

REACH & RoHS
COMPLIANT

REV.	ECN / DESCRIPTION	BY	DATE
A0	NEW	MQ.Qu	2018.07.06

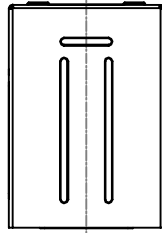

TOP VIEW

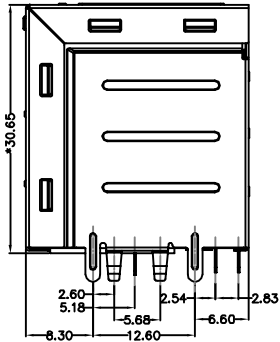

LEFT SIDE VIEW

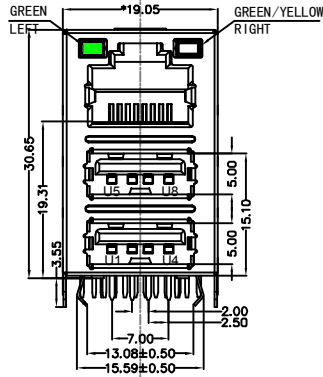

FRONT VIEW

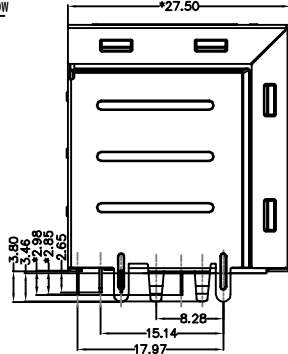

RIGHT SIDE VIEW

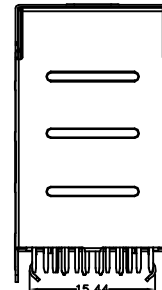

BACK VIEW

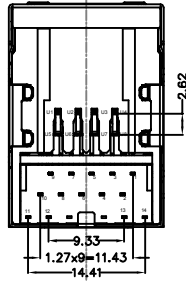

BOTTOM VIEW

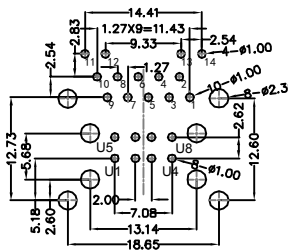

RECOMMENDED PCB LAYOUT
VIEWED FROM COMPONENT SIDE

MATERIAL:

HOUSING: PBT,UL94V-0,BLACK.
 USB HOUSING: PBT,UL94V-0, WHITE.
 TERMINALS BRACKET: PBT,UL94V-0,BLACK.
 SHIELD: SPCC.
 TERMINAL: PHOSPHOR BRONZE ,T=0.25MM,
 6U" GOLD PLATING ON CONTACT AREA.
 USB TERMINAL: PHOSPHOR BRONZE ,T=0.25MM,
 1U" GOLD PLATING ON CONTACT AREA.

MECHANICAL:

DURABILITY: 750 CYCLES MIN.
 MATING FORCE : 23N MAX.
 OPERATING TEMPERATURE: 0°C~+70°C.
 STORAGE TEMPERATURE: -40°C~+85°C.
 ALL CRITICAL DIMENSIONS WITH "*"

 苏州沃虎电子科技有限公司
SUZHOU WO HU ELECTRONIC TECHNOLOGY CO.,LTD

TITLE: RJ45+双USB2.0 1000BASE	SIZE A4	UNITS MM[INCH]	GENERAL TOLERANCES UNLESS SPECIFIED		APPROVED BY: JP.Gong
PART NO.: SYT 711Q009AE3RWD080	SACLE 1:1	REV A0	x±0.35	x°±3.0°	CHECKED BY: TW.Xu
REMARK:	SHEET 1/3		.x±0.30	.x°±2.0°	DESIGND BY: MQ.Qu
			.xx±0.25	.xx°±1.5°	
			.xxx±0.10	.xxx°±1.0°	

REACH & RoHS
COMPLIANT

REV.	ECN / DESCRIPTION	BY	DATE
A0	NEW	MQ.Qu	2018.07.06

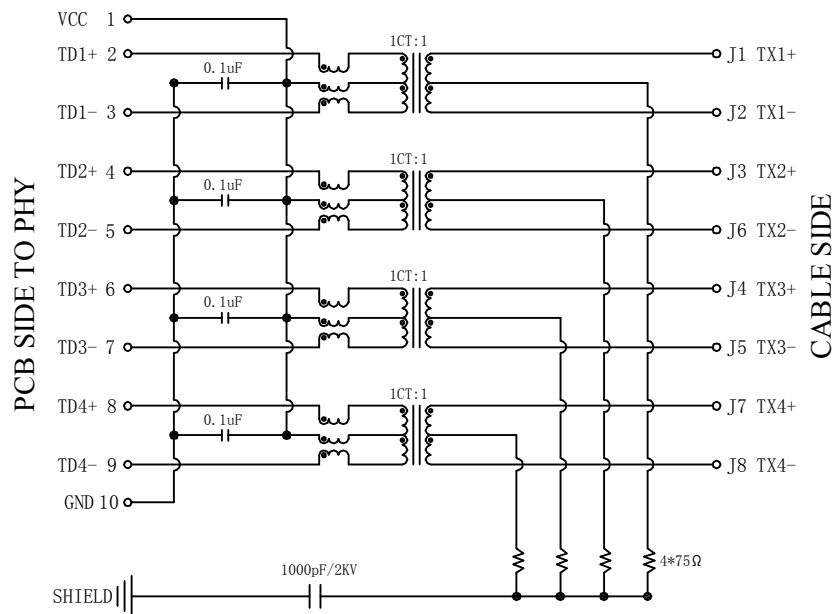

Electrical:

- Turn ratio: 2~3: J1~J2=1CT:1CT(±2%).
4~5: J3~J6=1CT:1CT(±2%).
6~7: J4~J5=1CT:1CT(±2%).
8~9: J7~J8=1CT:1CT(±2%).
- OCL: 350uH Min. at 100KHz 100mV 8mA DC.
- Insertion Loss: -1.0 dB Max 1~100MHz.
- Return loss: -20dB Min 1~10MHz;
-16dB Min 10~30MHz;
-12dB Min 30~60MHz;
-10dB Min 60~80MHz.
- Cross talk: -40dB Min 1~30MHz;
-35dB Min 30~60MHz;
-30dB Min 60~100MHz;
- CMR: -35dB Min 1~100MHz;
- Hi-Pot: 1500V AC & 2250V DC
6S 1mA PRI TO SEC

LED Specification

Standard LED Color	LED Wavelength	Foward(A)	Foward(V)
Green	568nm	20mA	1.85-2.45V
Yellow	585nm	20mA	1.7-2.2V

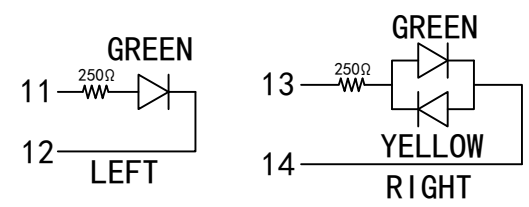

 苏州沃虎电子科技有限公司
SUZHOU WOHU ELECTRONIC TECHNOLOGY CO.,LTD

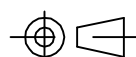
TITLE: RJ45+双USB2.0 1000BASE	SIZE A4	UNITS MM[INCH]	GENERAL TOLERANCES UNLESS SPECIFIED		APPROVED BY: JP.Gong
PART NO.: SYT 711Q009AE3RWD080	SACLE 1:1	REV A0	x±0.35	x°±3.0°	CHECKED BY: TW.Xu
REMARK:	SHEET 2/3		.xx±0.25	.xx°±1.5°	DESIGND BY: MQ.Qu
			.xxx±0.10	.xxx°±1.0°	

REACH & RoHS
COMPLIANT

PROFILE OF WAVE SOLDER

REV.	ECN / DESCRIPTION	BY	DATE
A0	NEW	MQ.Qu	2018.07.06

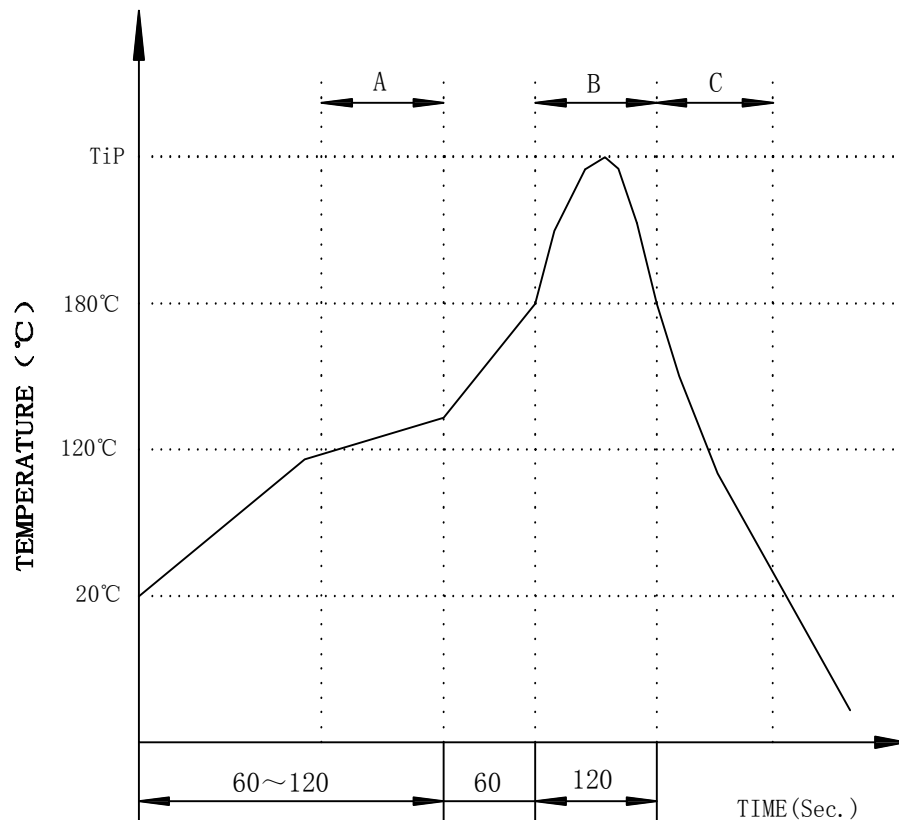

A.Preheating B.Soldering C.Gradual Cooling
 Tip temperature:260±5°C.
 Tip temperature time:5Sec Max.
 Tip melting point of Sn96.5/Ag3/Cu0.5:217°C.

Remarks: after wave soldering, the plastic positioning columns of the product which under the PCB will be slightly melted, but it won't affect its function.

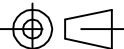
 苏州沃虎电子科技有限公司 SUZHOU WOHU ELECTRONIC TECHNOLOGY CO.,LTD	TITLE: RJ45+双USB2.0 1000BASE	SIZE A4	UNITS MM[INCH]	GENERAL TOLERANCES UNLESS SPECIFIED		APPROVED BY: JP.Gong
	PART NO.: SYT 711Q009AE3RWD080	SACLE 1:1	REV A0	$x \pm 0.35$ $x \pm 0.30$	$x^\circ \pm 3.0^\circ$ $.x^\circ \pm 2.0^\circ$	CHECKED BY: TW.Xu
	REMARK:	SHEET 3/3		$.xx \pm 0.25$ $.xxx \pm 0.10$	$.xx^\circ \pm 1.5^\circ$ $.xxx^\circ \pm 1.0^\circ$	DESIGND BY: MQ.Qu