

Customer drawings

- NOTE:
MATERIAL:
1. CONTACT: PHOSPHOR BRONZE T=0.20mm.
2. CONNECTOR HOUSING: HIGH TEMPERATURE PLASTIC UL 94V-0. COLOR: BLACK.
3. MOULDED INSERT: HIGH TEMPERATURE PLASTIC UL 94V-0. COLOR:BLACK.
4. CAGE: COPPER ALLOY T=0.25mm.
5. LIGHT PIPES: POLYCARBONATE UL 94V-0. COLOR: CLEAR
6. LIGHT PIPE HOUSING: PBT+30%G.F UL 94V-0 COLOR:BLACK.
7. EMI CLIP: COPPER ALLOY T=0.06mm.
- PLATED:
1. CONTACT AREA : PLATING GOLD 0.76 MICROMETERS MINIMUM OVER 1.25~2.54 MICROMETERS NICKEL.
2. CONTACT NEEDLE EYE: 2.54~5.08 MICROMETERS MATTE TIN OVER 1.25~2.54 MICROMETERS NICKEL.
3. EMI CLIP: 2.54~5.08 MICROMETERS TIN OVER 0.76~2.54 MICROMETERS NICKEL.
- MECHANICAL REQUIREMENT:
1. DURABILITY: 100 CYCLES MINIMUM.
2. INSERTION AND EXTRACTION FORCE: 40N MAXIMUM & 11.5N MAXIMUM
- ENVIRONMENTAL:
1. LOW LEVEL CONTACT RESISTANCE(LLCR):
ΔR 10 MILLIOHMS MAXIMUM FOR SHIELD AND SIGNAL CONTACTS.
2. WITHSTANDING VOLTAGE: 300V AC/MAXIMUM.
3. INSULATION RESISTANCE: 1x10⁹ OHMS MINIMUM.
4. RATINGS CURRENT: 0.5 Amps MAXIMUM.
5. RATINGS VOLTAGE: 120 volts AC.
6. OPERATION: -40°C~+85°C.
7. STORAGE: -55°C~+105°C.
8. ROHS COMPLIANT

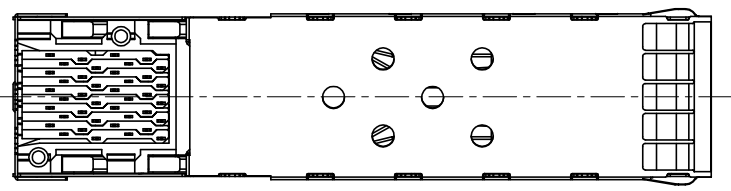
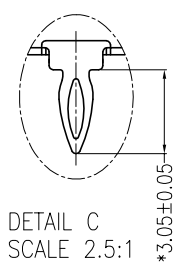
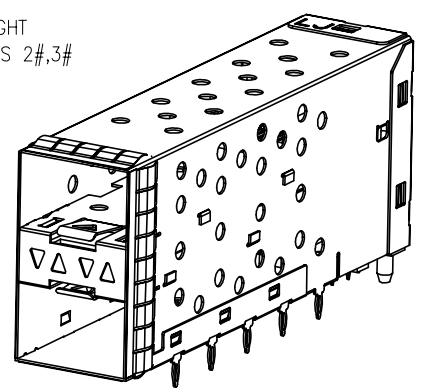
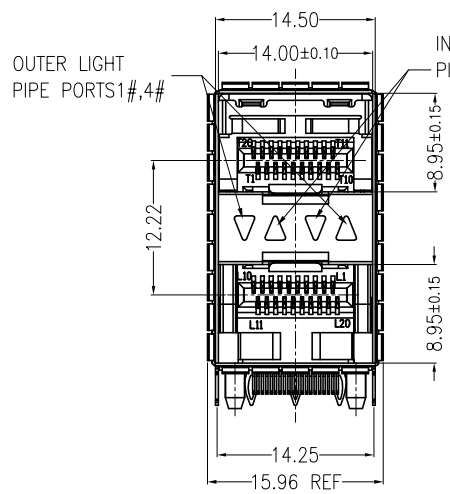
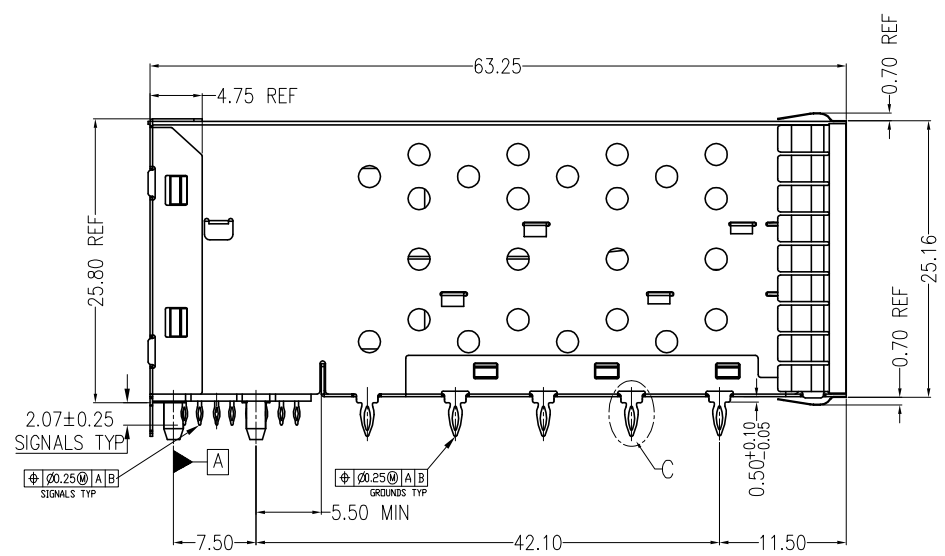
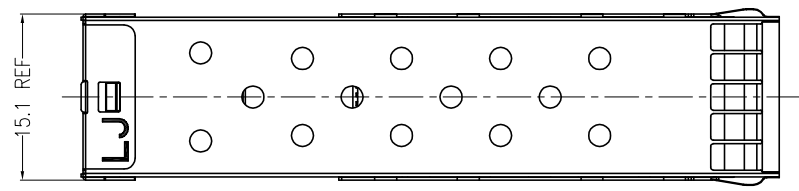

B	更改EMI弹片形状	/		shmily
A	正式版本发行	/		NEIL
版次	修改说明	ECN 编号		核准

自由公差		设计	2015.11.21
长度尺寸	角度尺寸		
X. ±0.25	X' ±0.5'	审核	2015.11.21
.X ±0.25	.X' ±0.5'		
.XX ±0.20	.XX' ±0.5'		
.XXX ±0.15		核准	2015.11.21
单位	mm	比例	1:1
A4	④	页次	1 of 3

苏州沃虎电子科技有限公司
SUZHOU WOHU ELECTRONIC TECHNOLOGY CO.,LTD

品名	SFP+ 2x1 Press Fit Connector
料号	81-121-50001-1
图号	ESFP14032701-C
版本	B

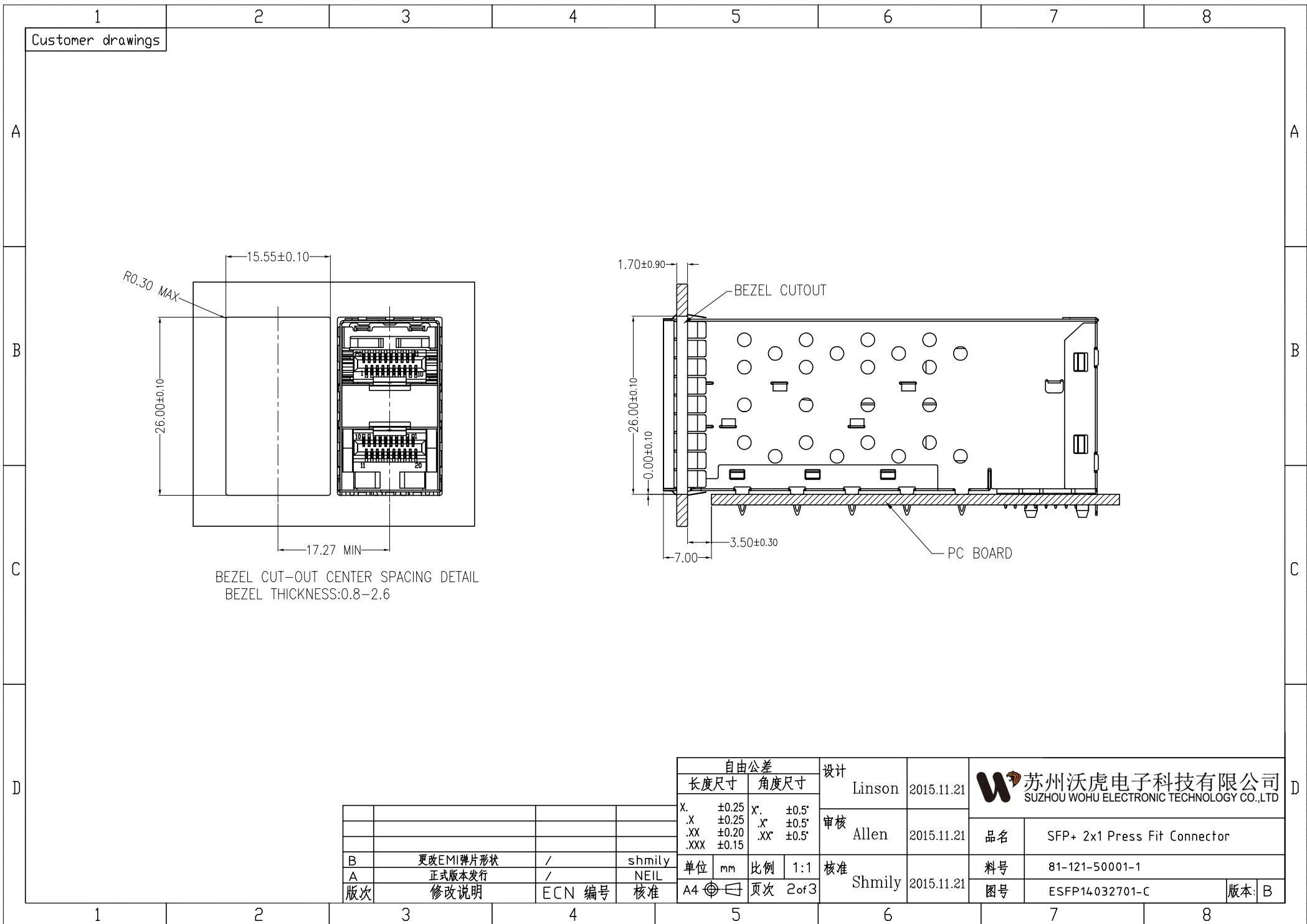

B	更改EMI弹片形状	/	shmily
A	正式版本发行	/	NEIL
版次	修改说明	ECN 编号	核准

自由公差			
长度尺寸		角度尺寸	
X.	±0.25	X°	±0.5°
.X	±0.25	.X°	±0.5°
.XX	±0.20	.XX°	±0.5°
.XXX	±0.15		
单位	mm	比例	1:1
A4	⊕	页次	2 of 3

设计	Linson	2015.11.21
审核	Allen	2015.11.21
核准	Shmily	2015.11.21

苏州沃虎电子科技有限公司 SUZHOU WOHU ELECTRONIC TECHNOLOGY CO.,LTD		品名	SFP+ 2x1 Press Fit Connector	
		料号	81-121-50001-1	
图号	ESFP14032701-C		版本:	B

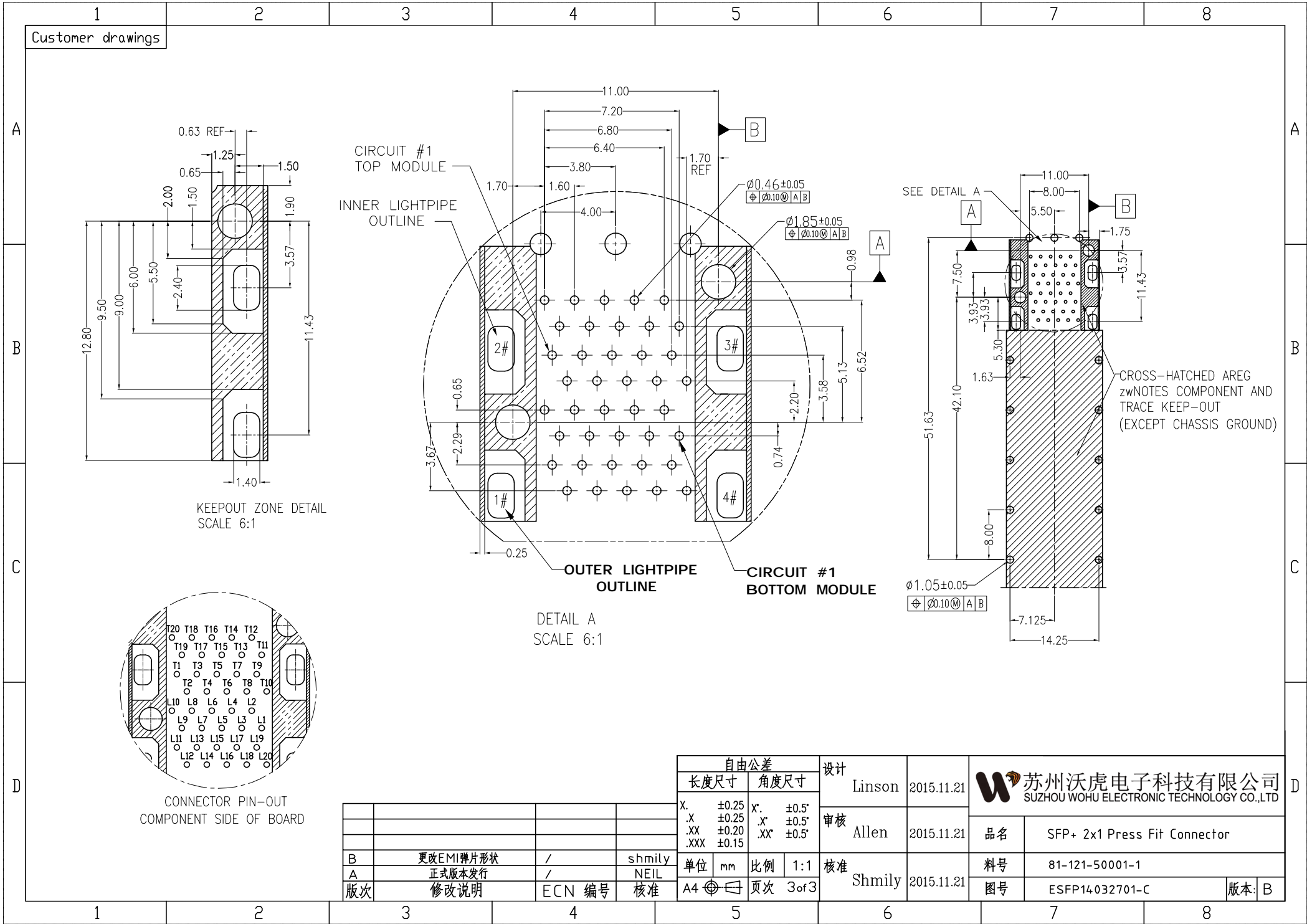

B	更改EMI弹片形状	/	sh mily
A	正式版本发行	/	NEIL
版次	修改说明	ECN 编号	核准

自由公差		设计	
长度尺寸	角度尺寸	Linson	2015.11.21
X. ±0.25	X° ±0.5°	审核	Allen
.X ±0.25	.X° ±0.5°		
.XX ±0.20	.XX° ±0.5°		
.XXX ±0.15		核准	Sh mily
单位	mm	比例	1:1
A4	⊕	页次	3 of 3

品名	SFP+ 2x1 Press Fit Connector
料号	81-121-50001-1
图号	ESFP14032701-C

苏州沃虎电子科技有限公司
SUZHOU WOHU ELECTRONIC TECHNOLOGY CO.,LTD

版本: B