

REACH & RoHS
COMPLIANT

REV.	ECN / DESCRIPTION	BY	DATE
A0	NEW	TW.Xu	2015.05.08

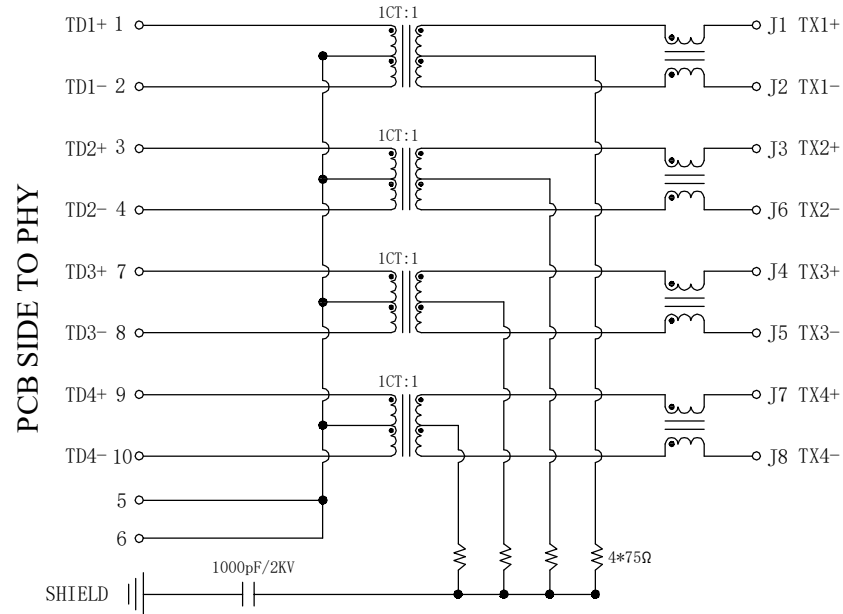



Electrical:

- Turn ratio: 1~2:J1~J2=1CT:1CT(±2%).
3~4:J3~J6=1CT:1CT(±2%).
7~8:J4~J5=1CT:1CT(±2%).
9~10:J7~J8=1CT:1CT(±2%).
- OCL:350uH Min.at 100KHz 100mV 8mA DC.
- Insertion Loss: -1.0 dB Max 1~100MHz.
- Return loss: -18dB Min 1~30MHz;
-14dB Min 30~60MHz.
-12dB Min 60~80MHz.
-10dB Min 80~100MHz.
- Cross talk: -40dB Min 1~30MHz;
-35dB Min 30~60MHz;
-30dB Min 60~100MHz;
- CMR: -30dB Min 1~100MHz;
- Hi-Pot: 2250V DC 6S 1mA PRI TO SEC

LED Specification

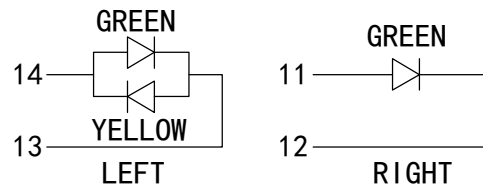
Standard LED Color	LED Wavelength	Foward(A)	Foward(V)
Green	568nm	20mA	1.85-2.45V
Yellow	585nm	20mA	1.7-2.2V

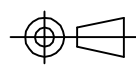

 苏州沃虎电子科技有限公司 Su Zhou Wo Hu Electronic Tech.Co.,Ltd.	TITLE: RJ45 1X1 1000BASE	SIZE A4	UNITS MM[INCH]	GENERAL TOLERANCES UNLESS SPECIFIED		APPROVED BY: JP.Gong
	PART NO.: SYT311Q070DJ3A4DN	SACLE 1:1	REV A0	x±0.35	x°±3.0°	CHECKED BY: TW.XU
	REMARK:	SHEET 2/3		.xx±0.25	.xx°±1.5°	DESIGND BY: TW.XU
				.xxx±0.10	.xxx°±1.0°	

REACH & RoHS
COMPLIANT

PROFILE OF WAVE SOLDER

REV.	ECN / DESCRIPTION	BY	DATE
A0	NEW	TW.Xu	2015.05.08

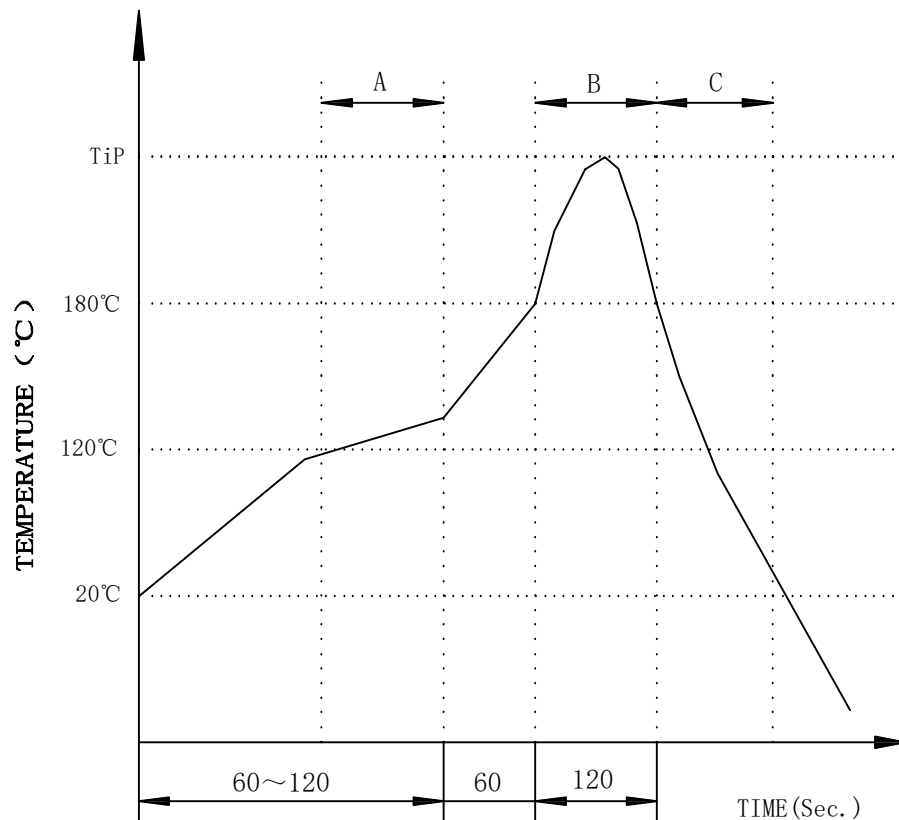

A.Preheating B.Soldering C.Gradual Cooling
 Tip temperature:260±5°C.
 Tip temperature time:5Sec Max.
 Tip melting point of Sn96.5/Ag3/Cu0.5:217°C.

Remarks: after wave soldering, the plastic positioning columns of the product which under the PCB will be slightly melted, but it won't affect its function.

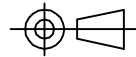
 苏州沃虎电子科技有限公司 Su Zhou Wo Hu Electronic Tech.Co.,Ltd.	TITLE: RJ45 1X1 1000BASE	SIZE A4	UNITS MM[INCH]	GENERAL TOLERANCES UNLESS SPECIFIED		APPROVED BY: JP.Gong
	PART NO.: SYT311Q070DJ3A4DN	SACLE 1:1	REV A0	x±0.35	x°±3.0°	CHECKED BY: TW.XU
	REMARK:	SHEET 3/3		.xx±0.25	.xx°±1.5°	DESIGND BY: TW.XU
				.xxx±0.10	.xxx°±1.0°	