

REV. 版本	ECN NO. 变更说明	DATE 日期
A-F	见老版图纸	
G	修改图纸	2018.08.08
H	调整标注	2019.08.05

SC02

NOTE:

MATERIAL:

- CONTACT: PHOSPHOR BRONZE.
- CONNECTOR HOUSING: LCP UL 94V-0. COLOR: BLACK.
- MOULDED INSERT: HIGH TEMPERATURE PLASTIC UL 94V-0. COLOR:BLACK.
- CAGE: COPPER ALLOY.
- LIGHT PIPES: POLYCARBONATE. UL 94V-0. COLOR:CLEAR
- LIGHT PIPE HOUSING: PBT UL 94V-0 COLOR:BLACK.

PLATED:

- CONTACT MATING AREA : PLATING GOLD OVER 1.27 MICROMETERS MINIMUM NICKEL.
- CONTACT NEEDLE EYE: 2.54 MICROMETERS MINIMUM MATTE TIN OVER 1.27 MICROMETERS MINIMUM NICKEL.

MECHANICAL REQUIREMENT:

- DURABILITY: 100 CYCLES MIN.
- INSERTION AND EXTRACTION FORCE: 40N MAX & 11.5N MAX

ENVIRONMENTAL:

- LOW LEVEL CONTACT RESITANCE(LLCR):
ΔR 10 MILLIOHMS MAXIMUM FOR SHIELD AND SIGNAL CONTACTS.
- DIELECTRIC WITHSTANDING VOLTAGE: 300V AC/MAX.
- INSULATION RESISTANCE: 1x10⁹ OHMS MINIMUM.
- RATINGS CURRENT: 0.5 AMPS MAX.
- RATINGS VOLTAGE: 30 VOLTS DC/AC(RMS) MAX.
- OPERATION: -40°C~+85°C.
- STORAGE: -55°C~+105°C.
- ROHS COMPLIANT

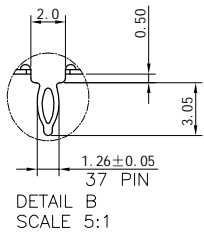
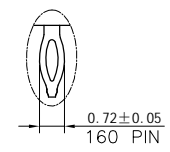
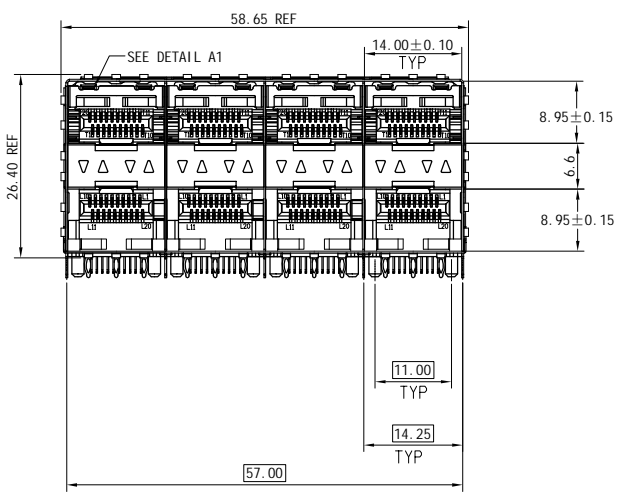
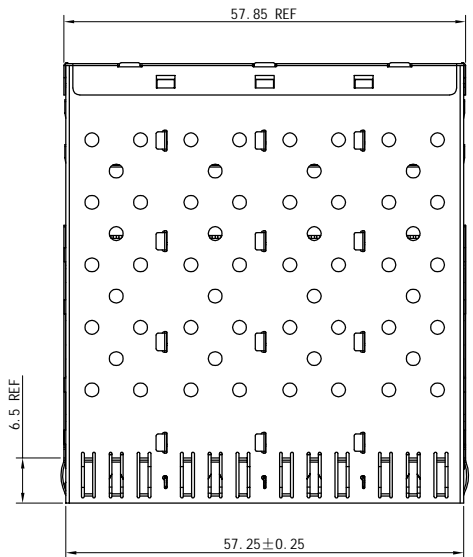
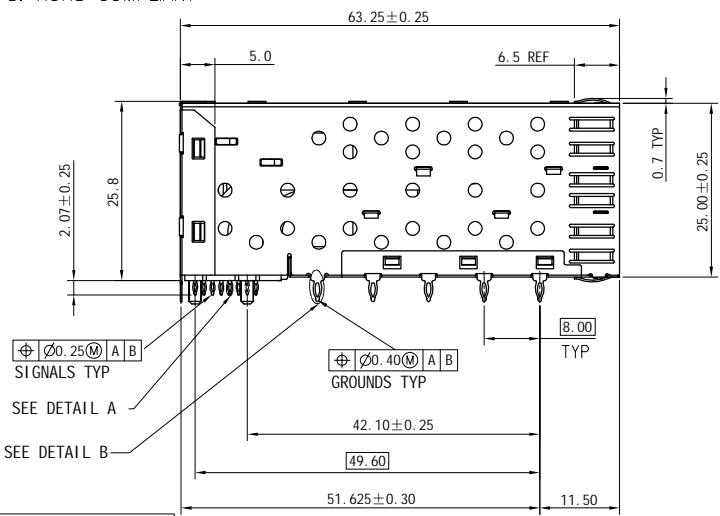

RoHS Compliant

WOHU 苏州沃虎电子科技有限公司
Tel:4001048018 http://www.wohu-tek.com

TOLERANCES 公差
.X ±0.25
.XX ±0.13
.XXX ±0.10
ANGLES: ±2°

Material: 材质
SEE NOTE
Finish: 电镀
SEE NOTE

Designed: 设计
Lamei Tang
Checked: 审核
Qi anpu Zhao
Approved: 核准
Robi n

NAME: 名称
SFP 2X4 CONNECTOR
DWG NO: 图号
ESFP-032-01-C
PART NO: 料号
SEE TABLE

REV. 版本
H

第三视角
A4
SIZE

SCALE 比例
2:1

UNIT 单位
mm

CUSTOMER: 客户
MODEL NO: 模号

N/A
N/A

SHEET 1 OF 5
第 页 共 页

REV. 版本	ECN NO. 变更说明	DATE 日期

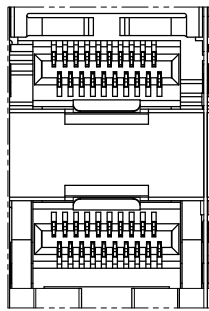

TYPE1_NONE LIGHT PIPES

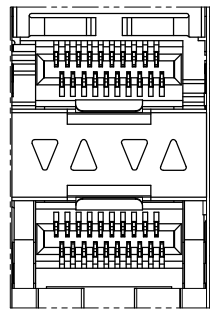

TYPE2_4 LIGHT PIPES

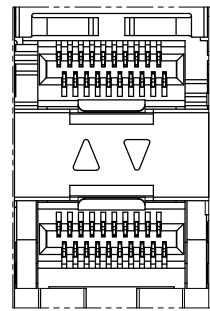

TYPE1_3 INNER LIGHT PIPES

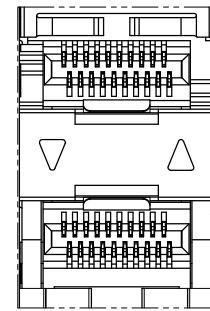

TYPE4_2 OUTER LIGHT PIPES

LIGHT PIPE CONFIGURATION
DETAIL D SCALE 2:1

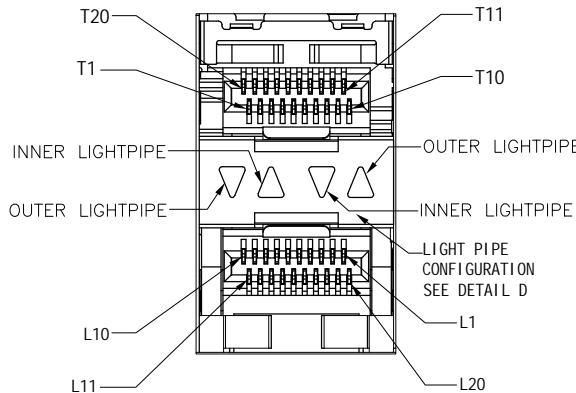

DETAIL A1
SCALE 4:1

10705624D001	B869S4-0015-Y004	SFP 2X4 PRESS FIT CONNECTOR	WITH INNER/OUTER LIGHT PIPES	▽△▽△	15u"	WITHOUT LOGO	UNPLATED
10705524D002	B869S4-0015-Y005	SFP 2X4 PRESS FIT CONNECTOR	WITHOUT LIGHT PIPES		15u"	WITHOUT LOGO	UNPLATED
10705624D002	B869S4-0015-Y006	SFP 2X4 PRESS FIT CONNECTOR	WITH OUTER LIGHT PIPES	▽△	15u"	WITHOUT LOGO	UNPLATED
10705624D022	B869S4-0015-Y007	SFP 2X4 PRESS FIT CONNECTOR	WITH INNER LIGHT PIPES	△▽	15u"	WITHOUT LOGO	UNPLATED
10705624F009	B869S4-0030-Y021	SFP 2X4 PRESS FIT CONNECTOR	WITH INNER/OUTER LIGHT PIPES	▽△▽△	30u"	WITHOUT LOGO	UNPLATED
10705524F002	B869S4-0030-Y022	SFP 2X4 PRESS FIT CONNECTOR	WITHOUT LIGHT PIPES		30u"	WITHOUT LOGO	UNPLATED
10705624F024	B869S4-0030-Y023	SFP 2X4 PRESS FIT CONNECTOR	WITH OUTER LIGHT PIPES	▽△	30u"	WITHOUT LOGO	UNPLATED
10705624F007	B869S4-0030-Y024	SFP 2X4 PRESS FIT CONNECTOR	WITH INNER LIGHT PIPES	△▽	30u"	WITHOUT LOGO	UNPLATED
10705624D023		SFP 2X4 PRESS FIT CONNECTOR	WITH INNER/OUTER LIGHT PIPES	▽△▽△	15u"	WITHOUT LOGO	Ni 30u"MIN
10705524D009		SFP 2X4 PRESS FIT CONNECTOR	WITHOUT LIGHT PIPES		15u"	WITHOUT LOGO	Ni 30u"MIN
10705624D013		SFP 2X4 PRESS FIT CONNECTOR	WITH OUTER LIGHT PIPES	▽△	15u"	WITHOUT LOGO	Ni 30u"MIN
10705624D024		SFP 2X4 PRESS FIT CONNECTOR	WITH INNER LIGHT PIPES	△▽	15u"	WITHOUT LOGO	Ni 30u"MIN
10705624F021		SFP 2X4 PRESS FIT CONNECTOR	WITH INNER/OUTER LIGHT PIPES	▽△▽△	30u"	WITHOUT LOGO	Ni 30u"MIN
10705524F010	B869S4-0030-Y030	SFP 2X4 PRESS FIT CONNECTOR	WITHOUT LIGHT PIPES		30u"	WITHOUT LOGO	Ni 30u"MIN
10705624F027		SFP 2X4 PRESS FIT CONNECTOR	WITH OUTER LIGHT PIPES	▽△	30u"	WITHOUT LOGO	Ni 30u"MIN
10705624F022	B869S4-0030-Y032	SFP 2X4 PRESS FIT CONNECTOR	WITH INNER LIGHT PIPES	△▽	30u"	WITHOUT LOGO	Ni 30u"MIN
PART NUMBER	PART NUMBER(OLD)	DESCRIPTION	LIGHT PIPES	CONTACT PALTING GOLD	LOGO	CAGE PLATING	

RoHS Compliant

WOHU 苏州沃虎电子科技有限公司
 Tel:4001048018 http://www.wohu-tek.com

第三视角	A4 SIZE	SCALE 比例 2:1	UNIT 单位 mm	CUSTOMER: 客户 MODEL NO: 模号	N/A N/A
------	------------	--------------------	------------------	------------------------------------	------------

TOLERANCES
公差
.X ±0.25
.XX ±0.13
.XXX ±0.10
ANGLES: ±2°

Material:
材质
电镀

SEE NOTE
SEE NOTE

Designed:
设计
Checked:
审核
Approved:
核准

Lamei Tang
Qi anpu Zhao
Robi n

NAME:
名称
DWG NO:
图号
PART NO:
料号

SFP 2X4 CONNECTOR
ESFP-032-01-C
SEE TABLE

REV.
版本
H

受控编号: QR-SF-002-002 1

REV. 版本	ECN NO. 变更说明	DATE 日期

SC02

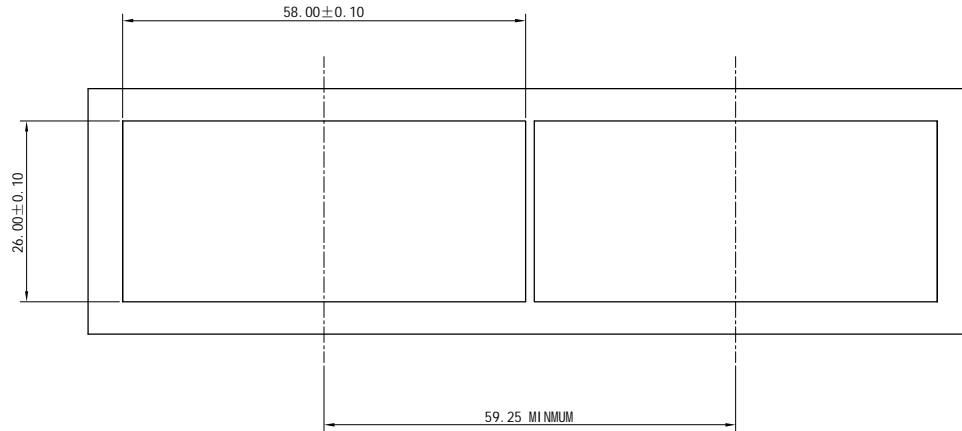

BEZEL CUT-OUT CENTER SPACING DETAIL
BEZEL THICKNESS: 0.8-2.6

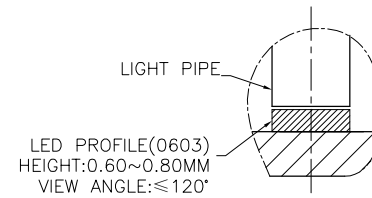
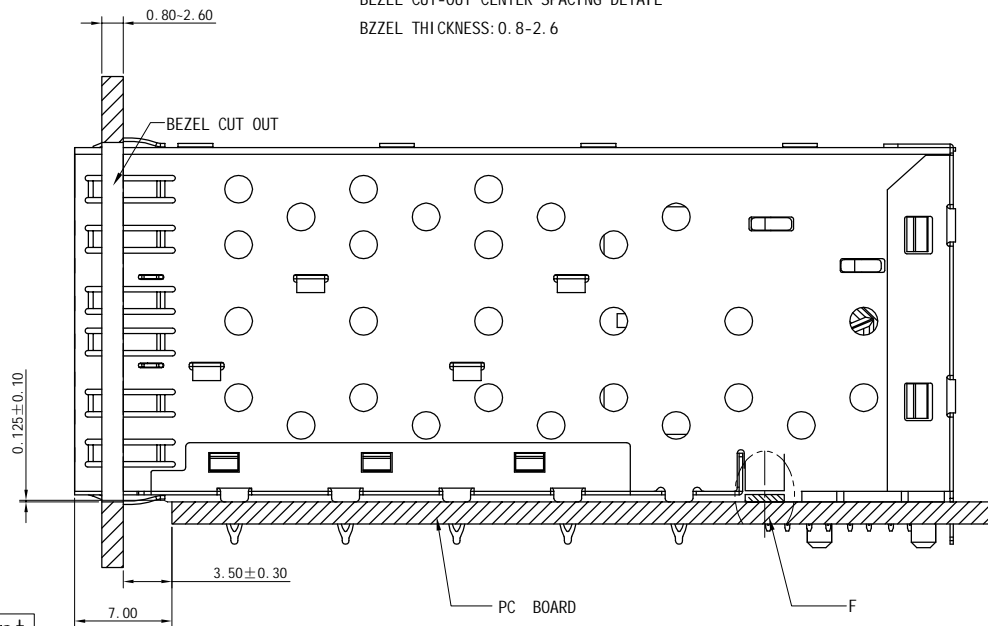

DETAIL F
SCALE 4:1

RoHS Compliant

WOHU 苏州沃虎电子科技有限公司
Tel:4001048018 <http://www.wohu-tek.com>

第三视角	A4 SIZE	SCALE 比例	UNIT 单位	CUSTOMER: 客户	N/A
		2:1	mm	MODEL NO: 模号	N/A

TOLERANCES
公差
.X ±0.25
.XX ±0.13
.XXX ±0.10
ANGLES: ±2°

Material: 材质	SEE NOTE	Designed: 设计	Lamei Tang	NAME: 名称	SFP 2X4 CONNECTOR
Finish: 电镀	SEE NOTE	Checked: 审核	Qi anpu Zhao	DWG NO: 图号	ESFP-032-01-C
SHEET 3 OF 5 第 3 页 共 5 页		Approved: 核准	Robi n	PART NO: 料号	SEE TABLE

REV. 版本	H
------------	---

REV. 版本	ECN NO. 变更说明	DATE 日期

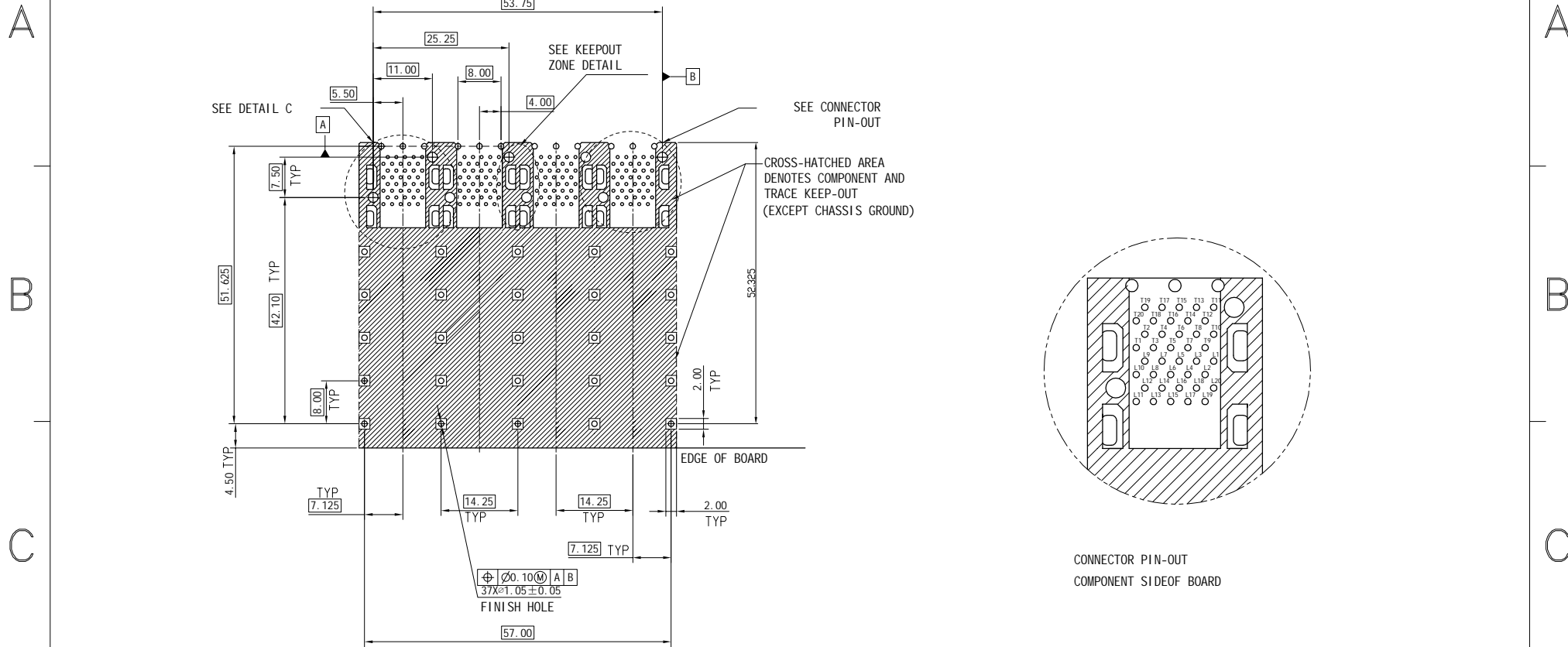

RECOMMENDED PCB LAYOUT-COMPONENT SIDE
 RECOMMENDED PCB THICKNESS-2.63MM

THE ENTIRE AREA OF THE CONNECTOR FOOTPRINT
 TO BE CONSIDERED THE KEEP OUT AREA FOR COMPONENTS
 (OTHER THAN LIGHT PIPE LED'S)
 THIS AREA IS INDICATED BY THE DASHED LINE

RoHS Compliant

WOHU 苏州沃虎电子科技有限公司
 Tel:4001048018 <http://www.wohu-tek.com>

TOLERANCES 公差
 .X ±0.25
 .XX ±0.13
 .XXX ±0.10
 ANGLES: ±2°

Material: 材质 SEE NOTE
 Finish: 电镀 SEE NOTE

SHEET 4 OF 5
 第 4 页 共 5 页

Designed: 设计
 Checked: 审核
 Approved: 核准

Lamei Tang
 Qi anpu Zhao
 Robi n

NAME: 名称	SFP 2X4 CONNECTOR	REV. 版本
DWG NO: 图号	ESFP-032-01-C	H
PART NO: 料号	SEE TABLE	

第三视角
 A4
 SIZE

SCALE 比例: 2:1
 UNIT 单位: mm
 CUSTOMER: 客户: N/A
 MODEL NO: 模号: N/A

REV. 版本	ECN NO. 变更说明	DATE 日期

SC02

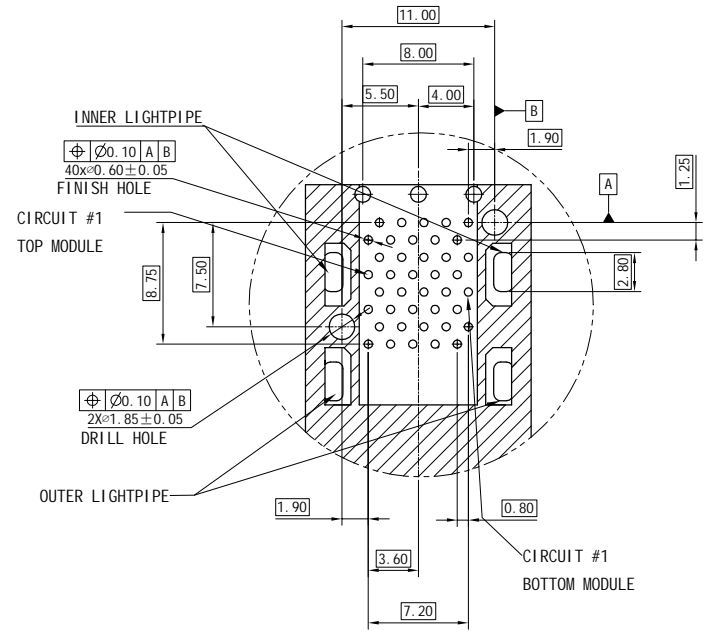

DETAIL C
SCALE 5:1

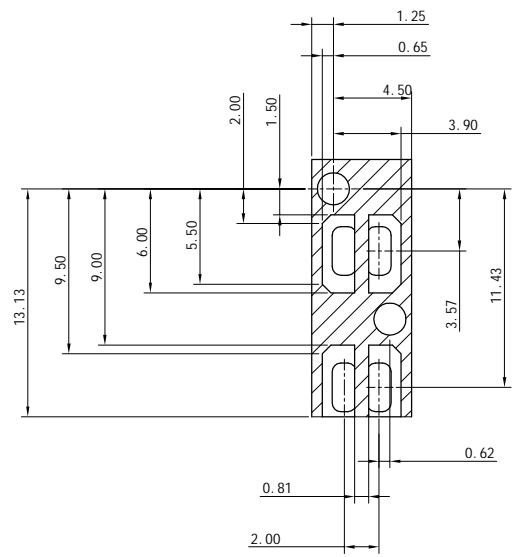

KEEPOUT ZONE
DETAIL SCALE 5:1

RoHS Compliant

WOHU 苏州沃虎电子科技有限公司
Tel:4001048018 http://www.wohu-tek.com

TOLERANCES
公差
.X ±0.25
.XX ±0.13
.XXX ±0.10
ANGLES: ±2°

Material:
材质
SEE NOTE
Finish:
电镀
SEE NOTE

Designed:
设计
Lamei Tang
Checked:
审核
Qi anpu Zhao
Approved:
核准
Robi n
SHEET 5 OF 5
第 5 页 共 5 页

NAME:
名称
SFP 2X4 CONNECTOR
DWG NO:
图号
ESFP-032-01-C
PART NO:
料号
SEE TABLE

REV. 版本
H

第三视角
A4
SIZE

SCALE
比例
2:1

UNIT
单位
mm

CUSTOMER:
客户
MODEL NO:
模号

N/A
N/A