

受控编号: QR-SF-002-002

CUSTOMER DRAWING

REV. 版本	ECN MO. 变更说明	DATE 日期
A	FIRST ISSUED	20121109
B	UPDATED DRAWING	20131111
C	UPDATED DRAWING	20140919
D	UPDATED DRAWING	20160913
E	ADD PART NO.	20190508
F	UPDATED DRAWING	20191119
G	UPDATED DRAWING	20210826

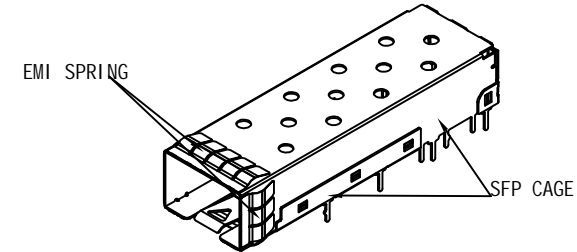
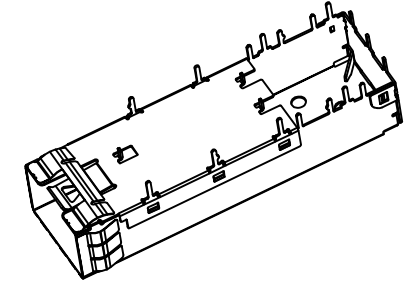
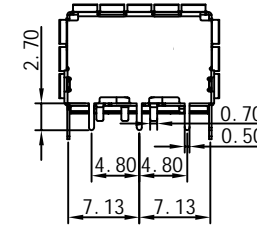
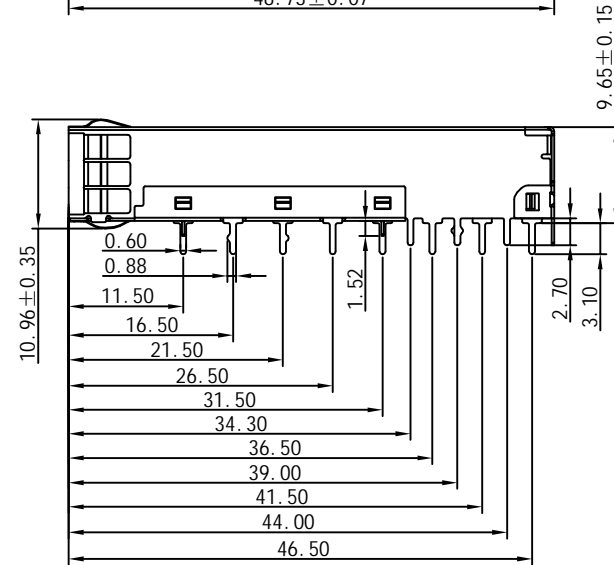
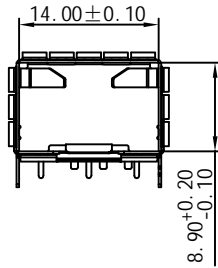
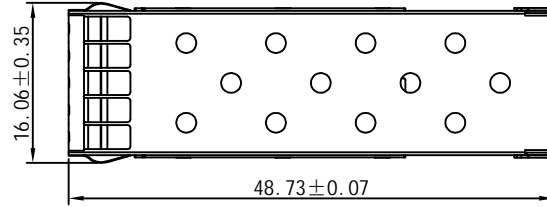

- NOTE:
- MATERIAL
SFP CAGE: COPPER ALLOY
EMI SPRING: COPPER ALLOY
 - FINISH
SFP CAGE: SEE TABLE
EMI SPRING: NI PLATED OVER ALL
 - TEMPERATURE
OPERATION: -40° C~+85° C
STORAGE: -55° C~+105° C
 - REFLOW SOLDERING: 260° C

TABLE

YT PART NUMBER	YF PART NUMBER	DESCRIPTION	PLATING
10710300Y001	K869-00-Y032	SFP+ 1X1 CAGE (Sol der) WITH LOGO	NON PLATING
10710311W006	K869-00-Y082	SFP+ 1X1 CAGE (Sol der) WITHOUT LOGO	NON PLATING
10710311W024		SFP+ 1X1 CAGE (Sol der) WITH LOGO	NI PLATING 30u"mi n
10710311W023		SFP+ 1X1 CAGE (Sol der) WITHOUT LOGO	NI PLATING 30u"mi n

RoHS Compliant

WOHU 苏州沃虎电子科技有限公司
Tel:4001048018 http://www.wohu-tek.com

SCALE 比例	UNIT 单位	CUSTOMER: 客户	MODEL NO: 型号
A3 SIZE	2:1 mm	N/A	N/A

TOLERANCES 公差
.X ±0.25
.XX ±0.13
.XXX ±0.10
ANGLES: ±2°

Material: 材质 SEE NOTE
Finish: 电镀 SEE NOTE
SHEET 1 OF 2
第 页 共 页

Designd: 设计 Henry
Checked: 审核 Jerry
Approved: 核准 Robi n

NAME: 名称	DWG NO: 图号	PART NO: 料号	REV. 版本
SFP+ 1X1 CAGE Sol der	ESFP09100501-C	SEE TABLE	G

REV.	CHANGE CONTENT	DATE

CUSTOMER DRAWING

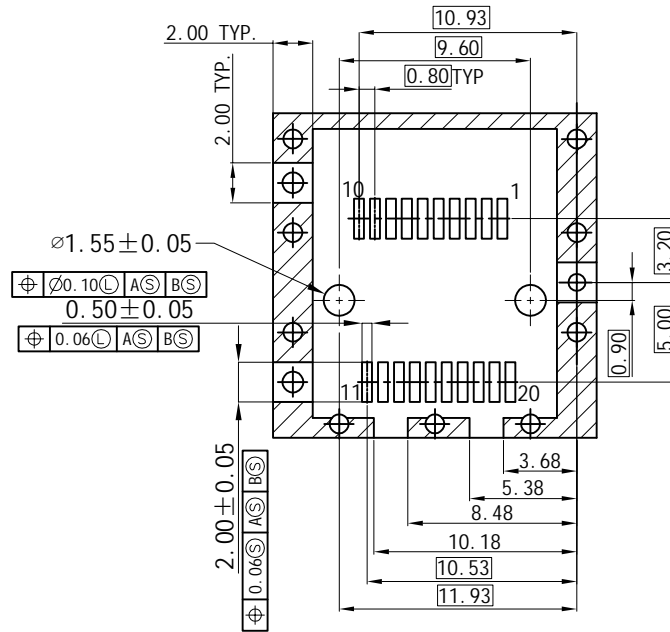
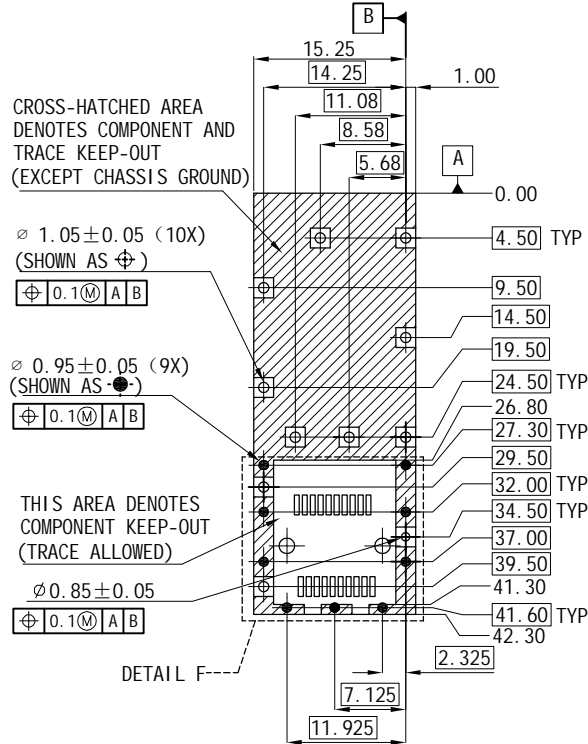
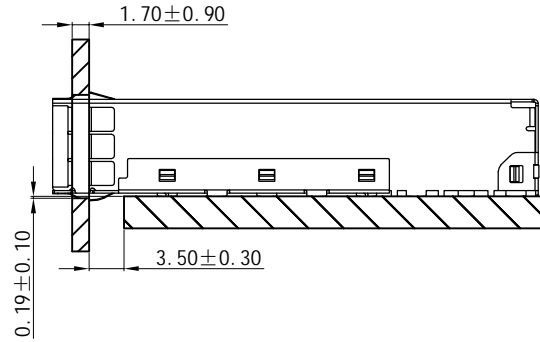
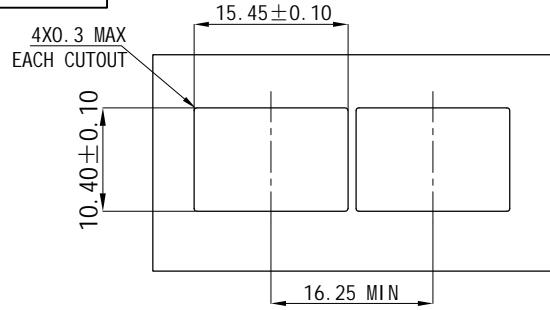

PCB LAYOUT (TOP VIEW)
PCB TOLERANCES: +/-0.05

DETAIL F
SCALE 4 : 1

RoHS Compliant

WOHU 苏州沃虎电子科技有限公司
Tel:4001048018 <http://www.wohu-tek.com>

TOLERANCES
公差
.X ±0.25
.XX ±0.13
.XXX ±0.10
ANGLES: ±2°

Material: SEE NOTE
材质
Finish: SEE NOTE
电镀
SHEET 2 OF 2
第 页 共 页

Designed: Henry
设计
Checked: Jerry
审核
Approved: Robin
核准

NAME: SFP+ 1X1 CAGE Sol der
名称
DWG NO: ESFP09100501-C
图号
PART NO: SEE TABLE
料号

REV. G
版本

第三视角	A3 SIZE	SCALE 比例	UNIT 单位	CUSTOMER: 客户	N/A
		2:1	mm	MODEL NO: 模号	N/A