

SC02

NOTE:
MATERIAL:

- CONTACT: PHOSPHOR BRONZE.
- CONNECTOR HOUSING: LCP UL 94V-0. COLOR: BLACK.
- MOULDED INSERT: HIGH TEMPERATURE PLASTIC UL 94V-0. COLOR:BLACK.
- CAGE: COPPER ALLOY.
- LIGHT PIPES: POLYCARBONATE. UL 94V-0. COLOR:CLEAR
- LIGHT PIPE HOUSING: PBT UL 94V-0 COLOR:BLACK.

PLATED:

- CONTACT MATING AREA : PLATING GOLD OVER 1.27 MICROMETERS MINIMUM NICKEL.
- CONTACT NEEDLE EYE: 2.54 MICROMETERS MINIMUM MATTE TIN OVER 1.27 MICROMETERS MINIMUM NICKEL.

MECHANICAL REQUIREMENT:

- DURABILITY: 100 CYCLES MIN.
- INSERTION AND EXTRACTION FORCE: 40N MAX & 11.5N MAX

ENVIRONMENTAL:

- LOW LEVEL CONTACT RESITANCE(LLCR):
ΔR 10 MILLIOHMS MAXIMUM FOR SHIELD AND SIGNAL CONTACTS.

- DIELECTRIC WITHSTANDING VOLTAGE: 300V AC/MAX.
- INSULATION RESISTANCE: 1×10^9 OHMS MINIMUM.
- RATINGS CURRENT: 0.5 AMPS MAX.
- RATINGS VOLTAGE: 30 VOLTS DC/AC(RMS) MAX.
- OPERATION: $-40^{\circ}\text{C} \sim +85^{\circ}\text{C}$.
- STORAGE: $-55^{\circ}\text{C} \sim +105^{\circ}\text{C}$.
- ROHS COMPLIANT

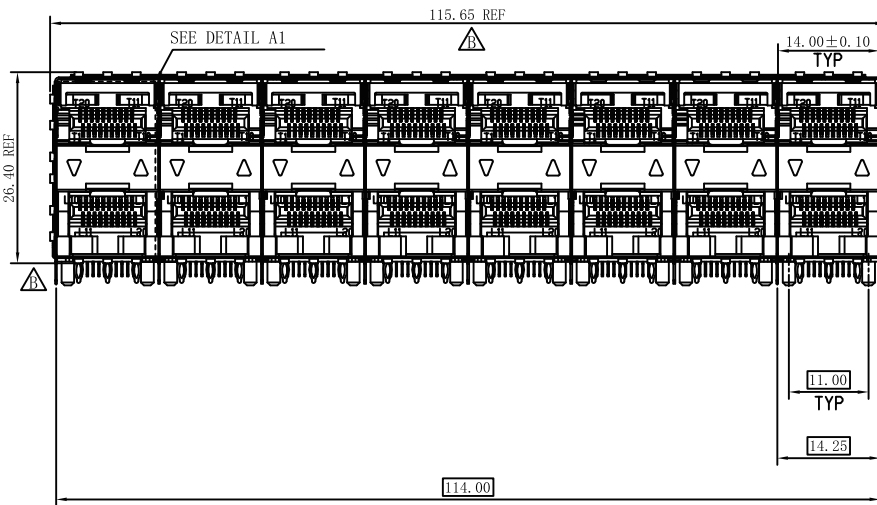
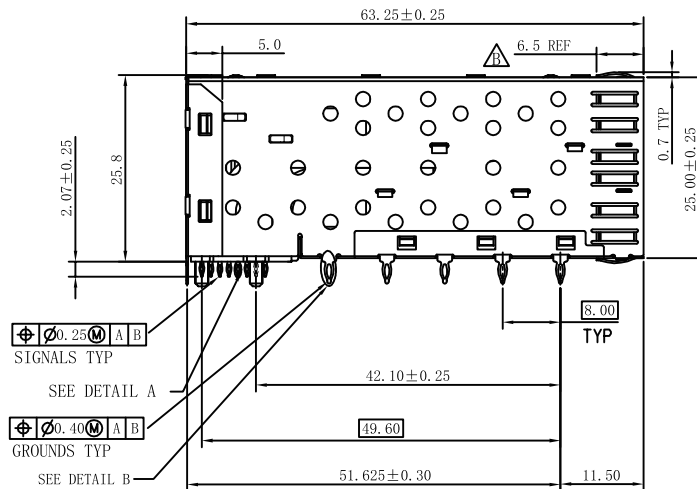
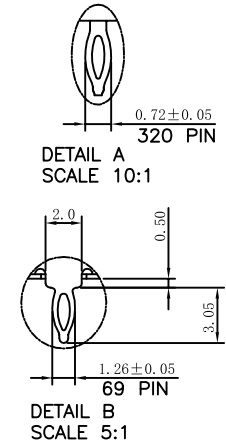
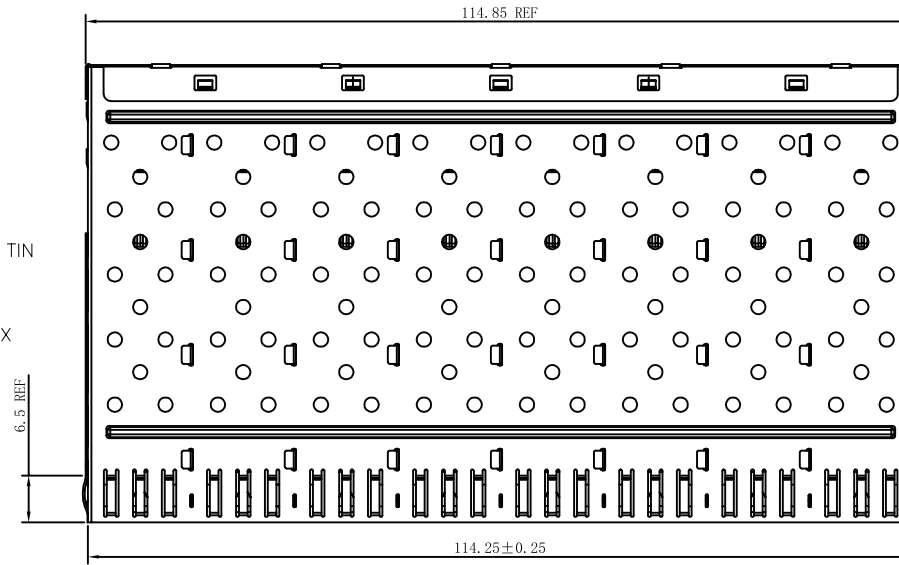

RoHS Compliant

沃虎 苏州沃虎电子科技有限公司
VOOHU Su Zhou Voohu Electronic Tech.Co.Ltd

TEL: +86 400 1048 018

WEB: WWW.WOHU-TEK.COM

TITLE:
SFP 2X8 CONNECTOR

PART NO.:
WHSFP06228D007

REMARK:
Gold plated 15u"

SIZE
A4

SACLE
1:1

SHEET
1/4

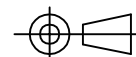

UNITS
MM[INCH]

GENERAL TOLERANCES
UNLESS SPECIFIED

$x \pm 0.35$
 $.xx^{\circ} \pm 1.5^{\circ}$
 $.xxx \pm 0.10$
 $.xxx^{\circ} \pm 1.0^{\circ}$

APPROVED BY:
Geoffrey. Song

CHECKED BY:
Elvis. Song

DESIGND BY:
Sunny. Xu

SC02

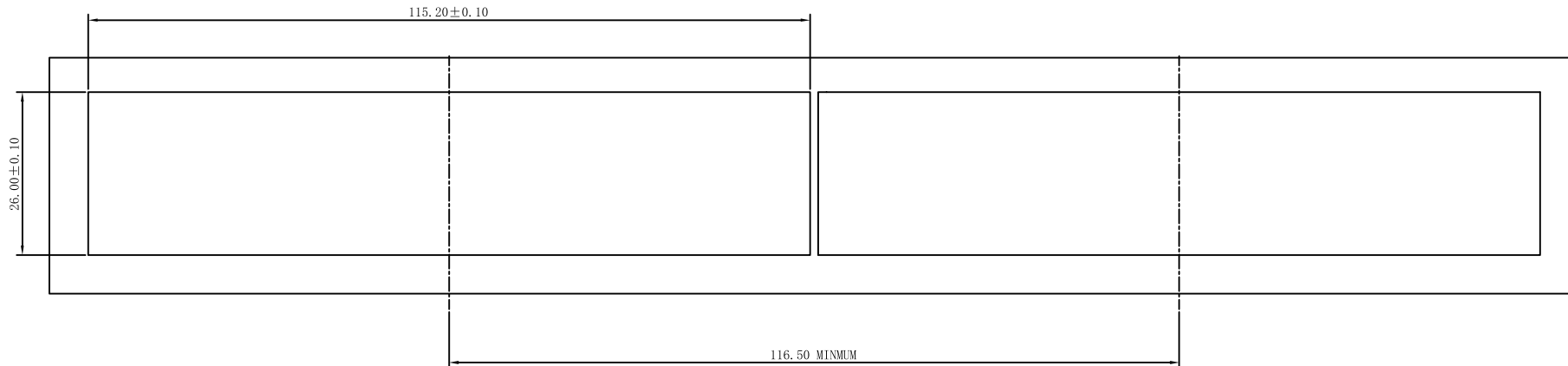

BEZEL CUT-OUT CENTER SPACING DETAIL
 BEZEL THICKNESS: 0.8~2.6

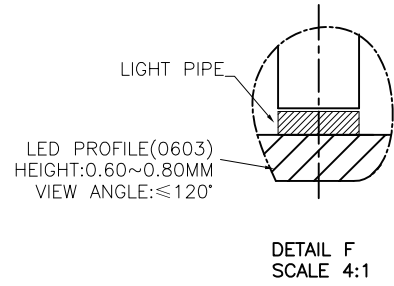
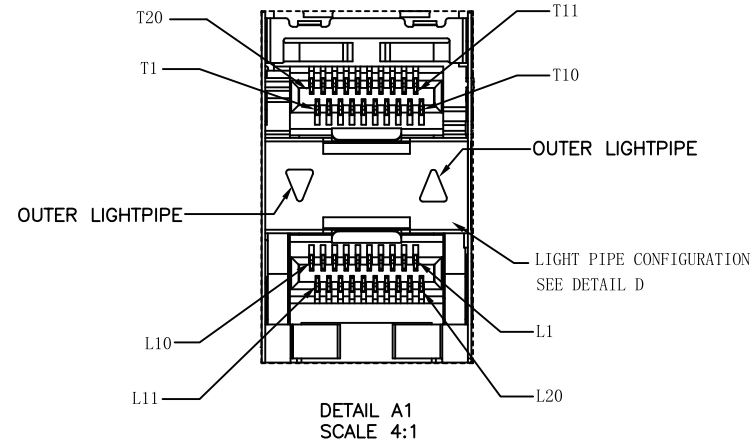
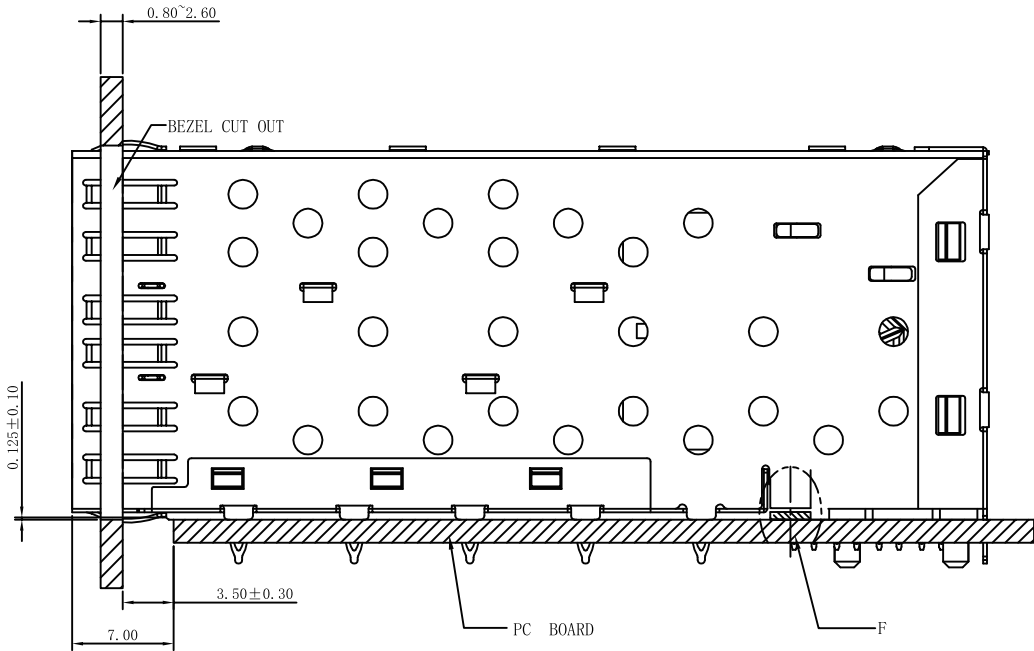

RoHS Compliant

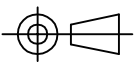
 沃虎 苏州沃虎电子科技有限公司 Su Zhou Voohu Electronic Tech.Co.Ltd	TITLE:	SFP 2X8 CONNECTOR	SIZE	A4	UNITS	MM[INCH]	GENERAL TOLERANCES UNLESS SPECIFIED		APPROVED BY:	Geoffrey.Song
	PART NO.:	WHSFP06228D007	SACLE	1:1	REV	A0	.x±0.35	x°±3.0°	CHECKED BY:	Elvis.Song
TEL: +86 400 1048 018 WEB: WWW.WOHU-TEK.COM	REMARK:	Gold plated 15u"	SHEET	1/4		.xx±0.25	.xx°±1.5°	DESIGND BY:	Sunny.Xu	
						.xxx±0.10	.xxx°±1.0°			

SC02

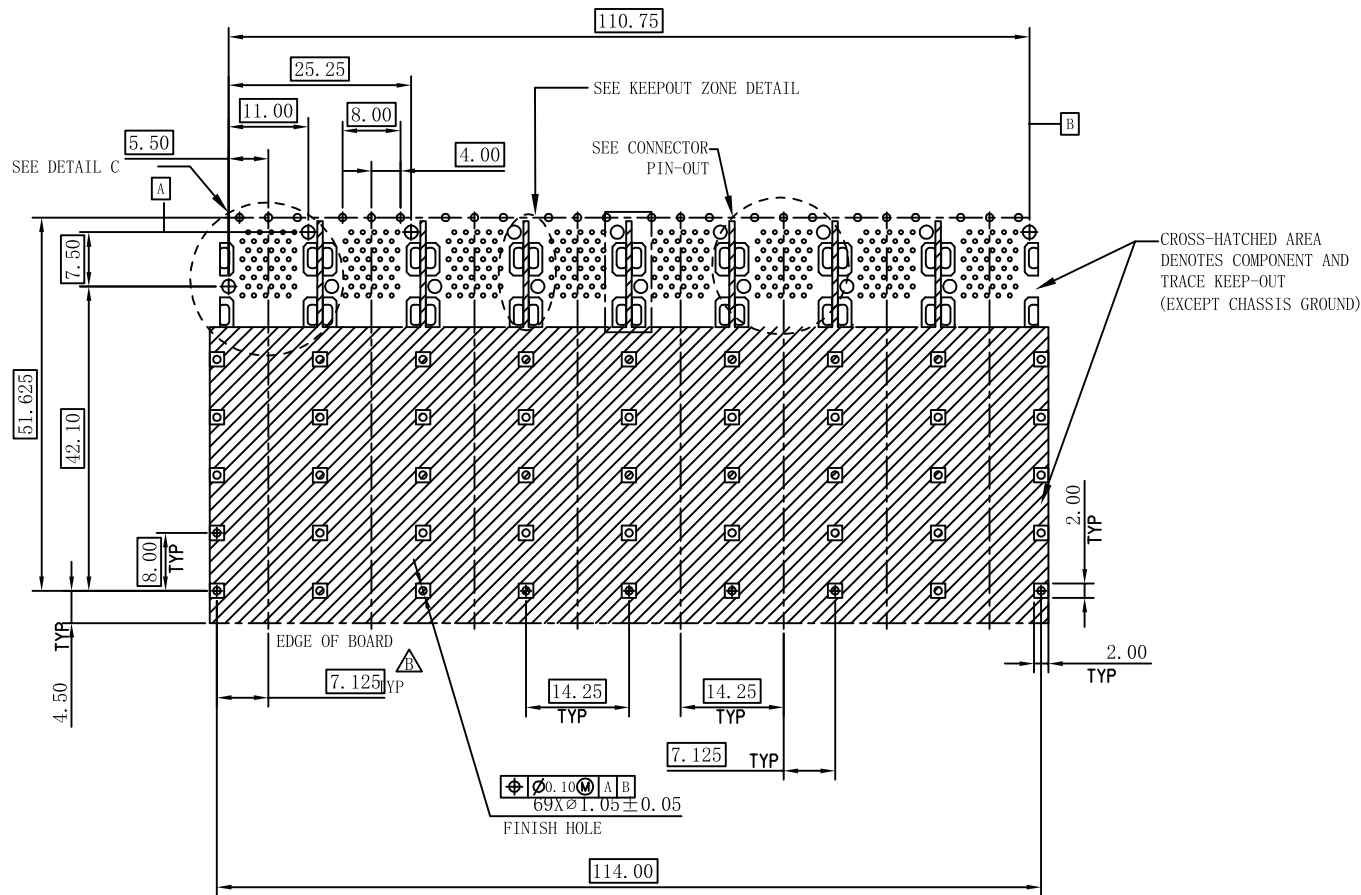

RECOMMENDED PCB LAYOUT-COMPONENT SIDE
RECOMMENDED PCB THICKNESS-2.63MM

THE ENTIRE AREA OF THE CONNECTOR FOOTPRINT
TO BE CONSIDERED THE KEEP OUT AREA FOR COMPONENTS
(OTHER THAN LIGHT PIPE LED'S)
THIS AREA IS INDICATED BY THE DASHED LINE

RoHS Compliant

 **沃虎** 苏州沃虎电子科技有限公司
VOOHU Su Zhou Voohu Electronic Tech.Co.Ltd

TITLE:
SFP 2X8 CONNECTOR

SIZE
A4

UNITS
MM[INCH]

GENERAL TOLERANCES
UNLESS SPECIFIED

APPROVED BY:
Geoffrey. Song

PART NO.:
WHSFP06228D007

SACLE
1:1

REV
A0

$x \pm 0.35$
 $.x \pm 0.30$

$x^\circ \pm 3.0^\circ$
 $.x^\circ \pm 2.0^\circ$

CHECKED BY:
Elvis. Song

REMARK:
Gold plated 15u"

SHEET
1/4

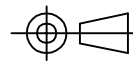

$.xx \pm 0.25$
 $.xxx \pm 0.10$

$.xx^\circ \pm 1.5^\circ$
 $.xxx^\circ \pm 1.0^\circ$

DESIGND BY:
Sunny. Xu

TEL: +86 400 1048 018

WEB: WWW.WOHU-TEK.COM

SC02

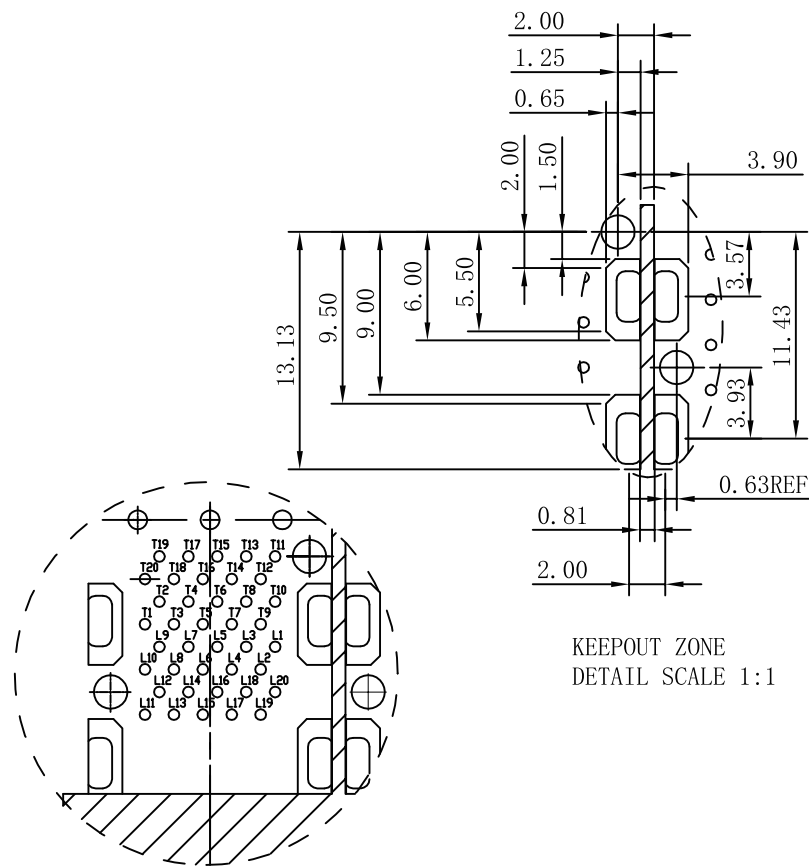
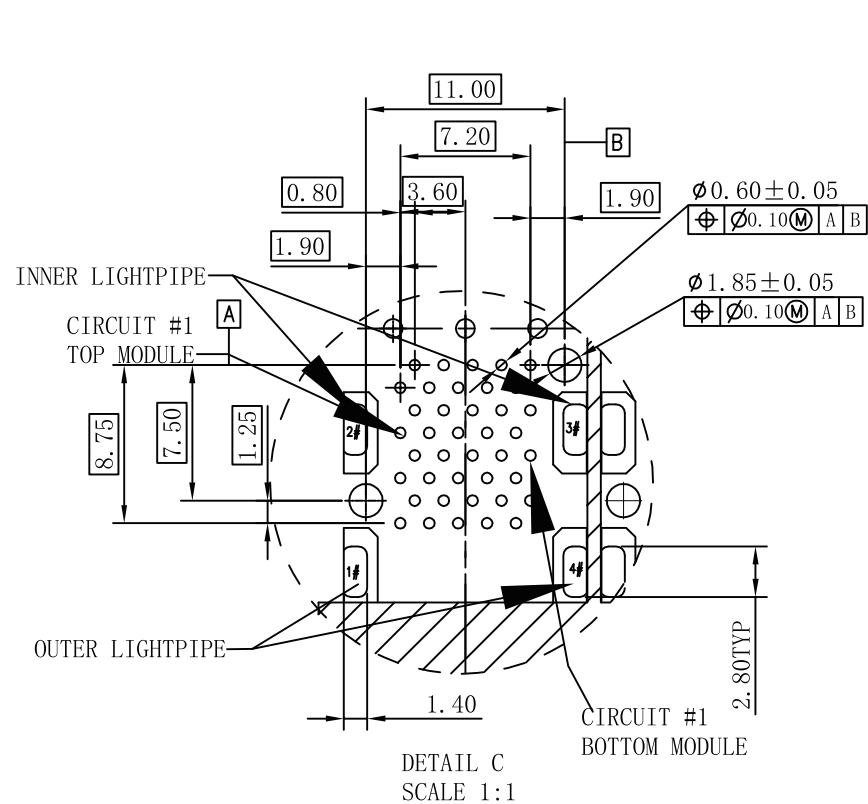

CONNECTOR PIN-OUT
COMPONENT SIDE OF BOARD

RoHS Compliant



TITLE: SFP 2X8 CONNECTOR	SIZE A4	UNITS MM[INCH]	GENERAL TOLERANCES UNLESS SPECIFIED		APPROVED BY: Geoffrey. Song
			x±0.35	x°±3.0°	
PART NO.: WHSFP06228D007	SCALE 1:1	REV A0	.x±0.30	.x°±2.0°	CHECKED BY: Elvis. Song
			.xx±0.25	.xx°±1.5°	
REMARK: Gold plated 15u"	SHEET 1/4		.xxx±0.10	.xxx°±1.0°	DESIGN BY: Sunny. Xu

TEL: +86 400 1048 018

WEB: WWW.WOHU-TEK.COM