

SC02

NOTE:
MATERIAL:

- CONTACT: PHOSPHOR BRONZE.
- CONNECTOR HOUSING: LCP UL 94V-0. COLOR: BLACK.
- MOULDED INSERT: HIGH TEMPERATURE PLASTIC UL 94V-0. COLOR:BLACK.
- CAGE: COPPER ALLOY.
- LIGHT PIPES: POLYCARBONATE. UL 94V-0. COLOR:CLEAR
- LIGHT PIPE HOUSING: PBT UL 94V-0 COLOR:BLACK.

PLATED:

- CONTACT MATING AREA : PLATING GOLD OVER 1.27 MICROMETERS MINIMUM NICKEL.
- CONTACT NEEDLE EYE: 2.54 MICROMETERS MINIMUM MATTE TIN OVER 1.27 MICROMETERS MINIMUM NICKEL.

MECHANICAL REQUIREMENT:

- DURABILITY: 100 CYCLES MIN.
- INSERTION AND EXTRACTION FORCE: 40N MAX & 11.5N MAX

ENVIRONMENTAL:

- LOW LEVEL CONTACT RESITANCE(LLCR):
ΔR 10 MILLIOHMS MAXIMUM FOR SHIELD AND SIGNAL CONTACTS.
- DIELECTRIC WITHSTANDING VOLTAGE: 300V AC/MAX.
- INSULATION RESISTANCE: 1×10^9 OHMS MINIMUM.
- RATINGS CURRENT: 0.5 AMPS MAX.
- RATINGS VOLTAGE: 30 VOLTS DC/AC(RMS) MAX.
- OPERATION: $-40^{\circ}\text{C} \sim +85^{\circ}\text{C}$.
- STORAGE: $-55^{\circ}\text{C} \sim +105^{\circ}\text{C}$.
- ROHS COMPLIANT

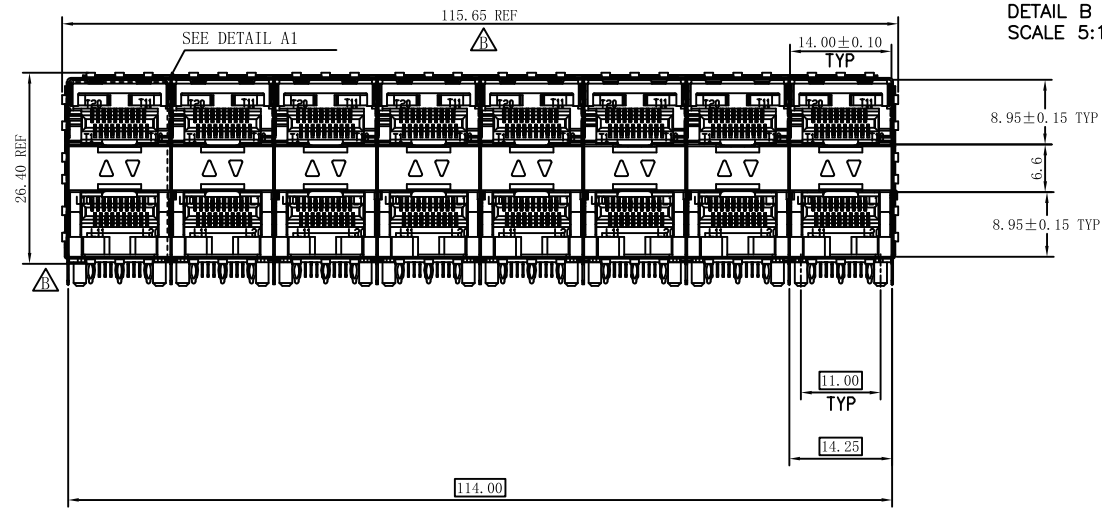
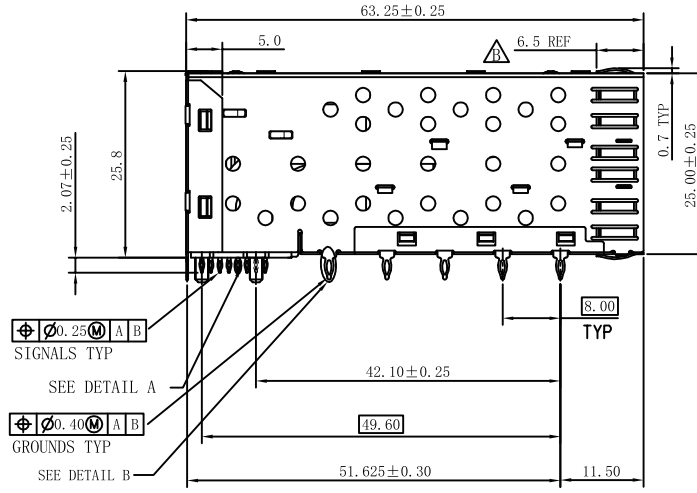
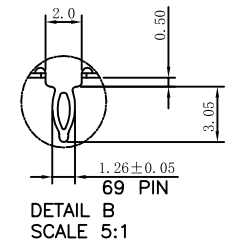
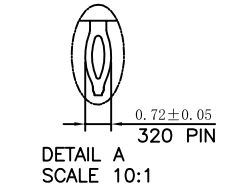
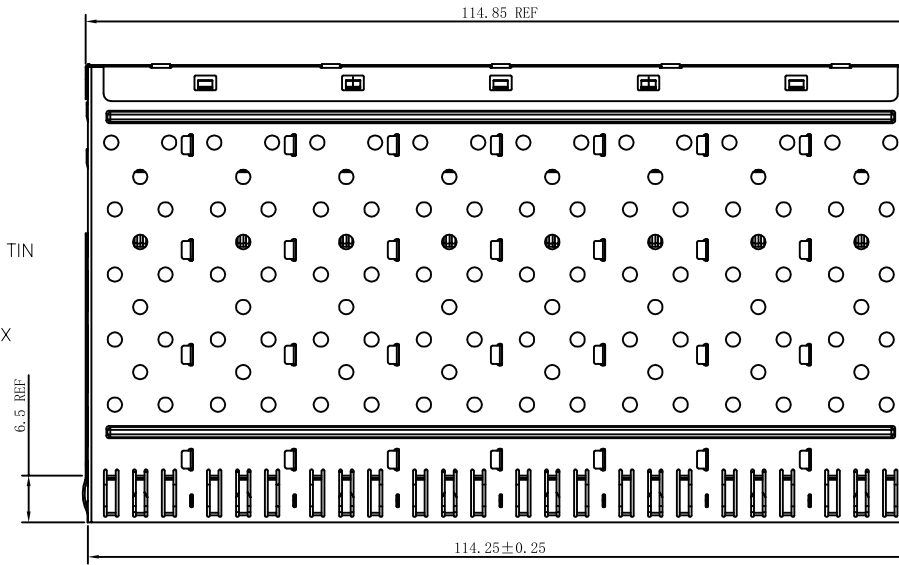

RoHS Compliant

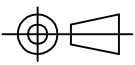
 沃虎 苏州沃虎电子科技有限公司 Su Zhou Voohu Electronic Tech.Co.Ltd	TITLE:	SIZE	UNITS	GENERAL TOLERANCES		APPROVED BY: Geoffrey.Song
	SFP 2X8 CONNECTOR	A4	MM[INCH]	UNLESS SPECIFIED		
	PART NO.:	SACLE	REV	x±0.35	x°±3.0°	CHECKED BY: Elvis.Song
	WHSFP06228D008	1:1	A0	.x±0.30	.x°±2.0°	
TEL: +86 400 1048 018 WEB: WWW.WOHU-TEK.COM	REMARK: Gold plated 15u"	SHEET 1/4		.xx±0.25	.xx°±1.5°	DESIGND BY: Sunny.Xu
				.xxx±0.10	.xxx°±1.0°	

SC02

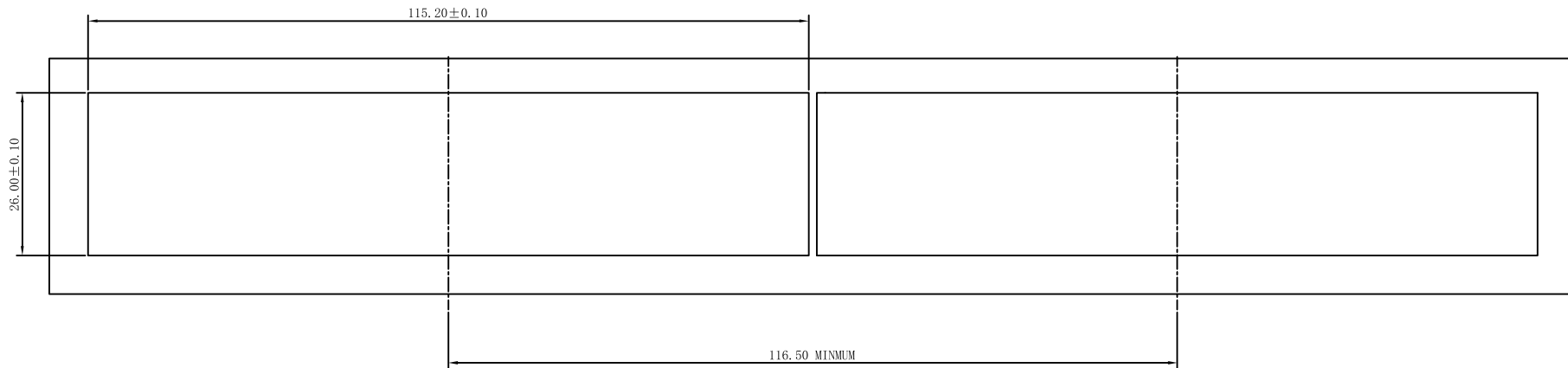

BEZEL CUT-OUT CENTER SPACING DETAIL
 BEZEL THICKNESS: 0.8~2.6

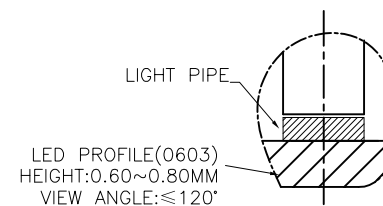
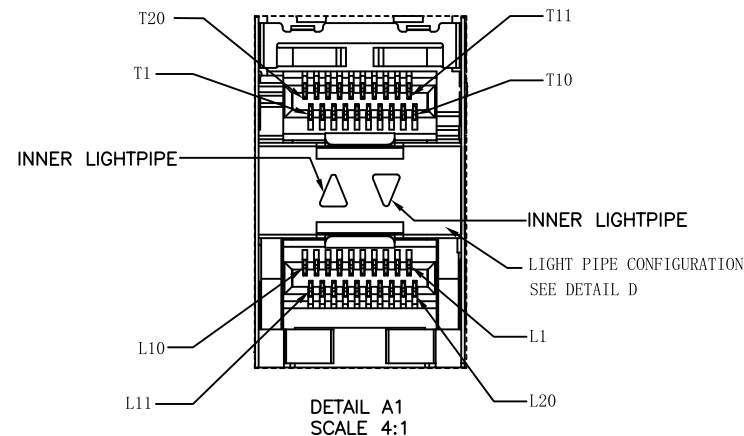
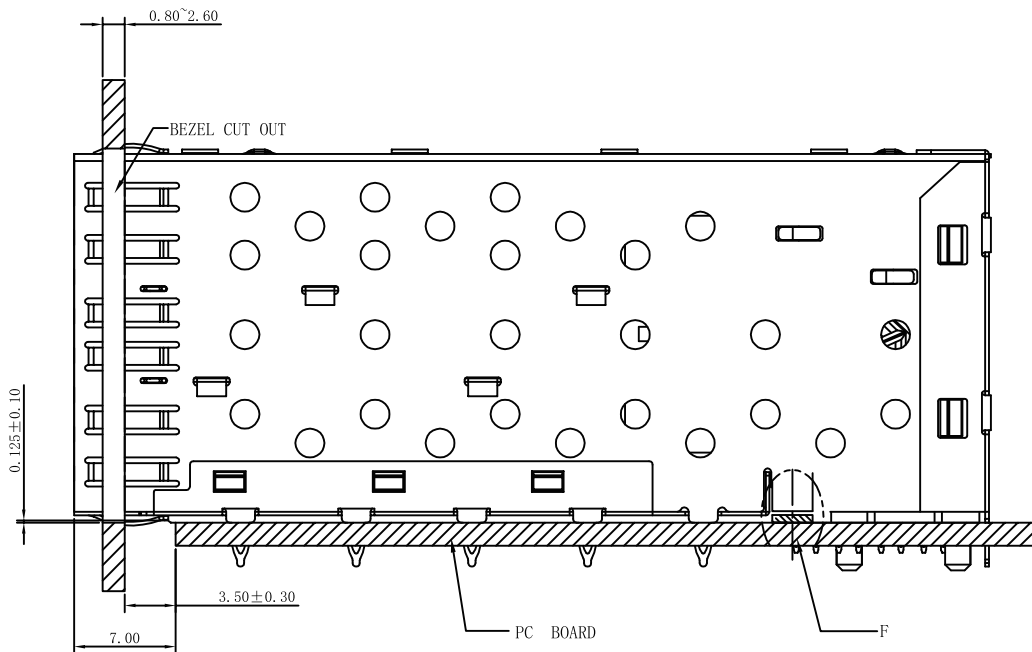

RoHS Compliant

沃虎 苏州沃虎电子科技有限公司
 VOOHU Su Zhou Voohu Electronic Tech.Co.Ltd

TITLE:
SFP 2X8 CONNECTOR

SIZE
A4

UNITS
MM[INCH]

GENERAL TOLERANCES
UNLESS SPECIFIED

APPROVED BY:
Geoffrey.Song

PART NO.:
WHSFP06228D008

SACLE
1:1

REV
A0

$x \pm 0.35$ $x^\circ \pm 3.0^\circ$
 $.x \pm 0.30$ $.x^\circ \pm 2.0^\circ$

CHECKED BY:
Elvis.Song

TEL: +86 400 1048 018

WEB: WWW.WOHU-TEK.COM

REMARK:
Gold plated 15u"

SHEET
1/4

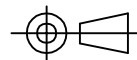

$.xx \pm 0.25$ $.xx^\circ \pm 1.5^\circ$
 $.xxx \pm 0.10$ $.xxx^\circ \pm 1.0^\circ$

DESIGND BY:
Sunny.Xu

SC02

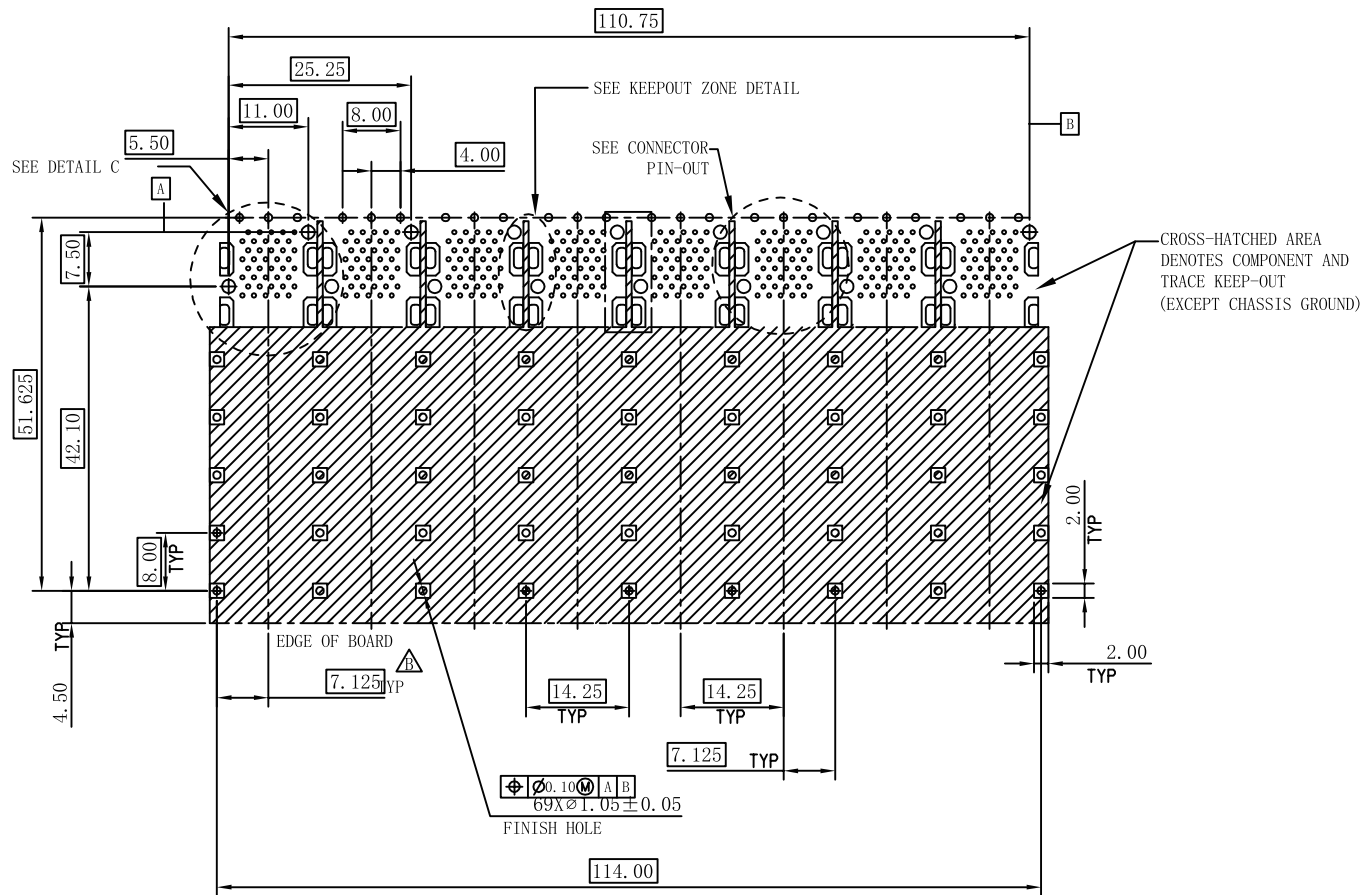

RECOMMENDED PCB LAYOUT—COMPONENT SIDE
 RECOMMENDED PCB THICKNESS—2.63MM

THE ENTIRE AREA OF THE CONNECTOR FOOTPRINT
 TO BE CONSIDERED THE KEEP OUT AREA FOR COMPONENTS
 (OTHER THAN LIGHT PIPE LED'S)
 THIS AREA IS INDICATED BY THE DASHED LINE

RoHS Compliant



Su Zhou Voohu Electronic Tech.Co.Ltd

TEL: +86 400 1048 018

WEB: WWW.WOHU-TEK.COM

TITLE: SFP 2X8 CONNECTOR	SIZE A4	UNITS MM[INCH]	GENERAL TOLERANCES UNLESS SPECIFIED		APPROVED BY: Geoffrey. Song
PART NO.: WHSFP06228D008	SACLE 1:1	REV A0	$x \pm 0.35$	$x^\circ \pm 3.0^\circ$	CHECKED BY: Elvis. Song
REMARK: Gold plated 15u"	SHEET 1/4		$.xx \pm 0.25$	$.xx^\circ \pm 1.5^\circ$	DESIGND BY: Sunny. Xu
			$.xxx \pm 0.10$	$.xxx^\circ \pm 1.0^\circ$	

SC02

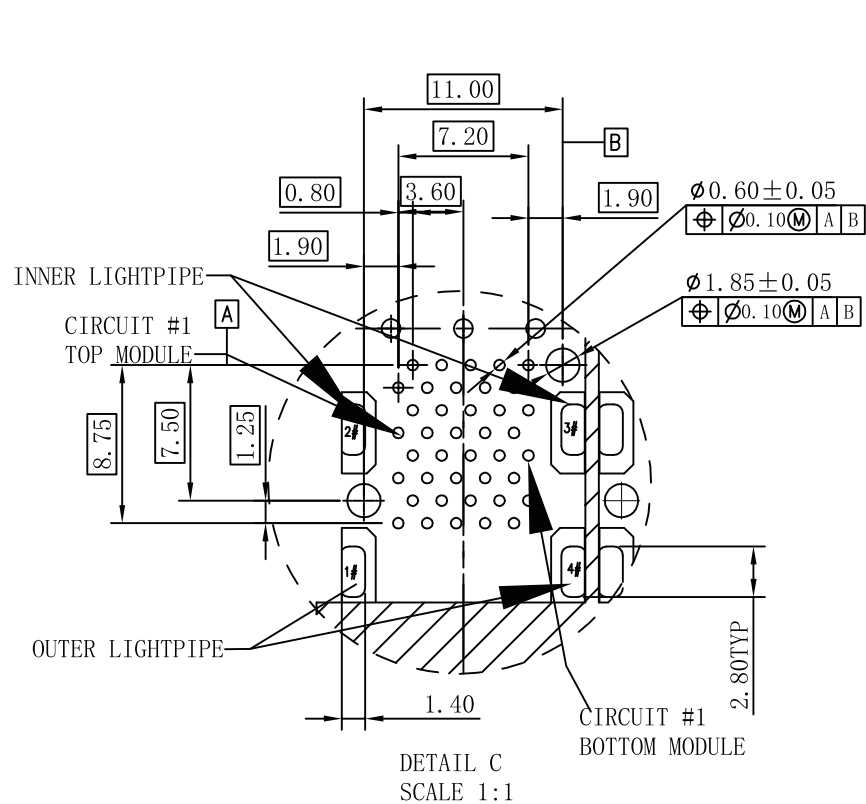

DETAIL C
SCALE 1:1

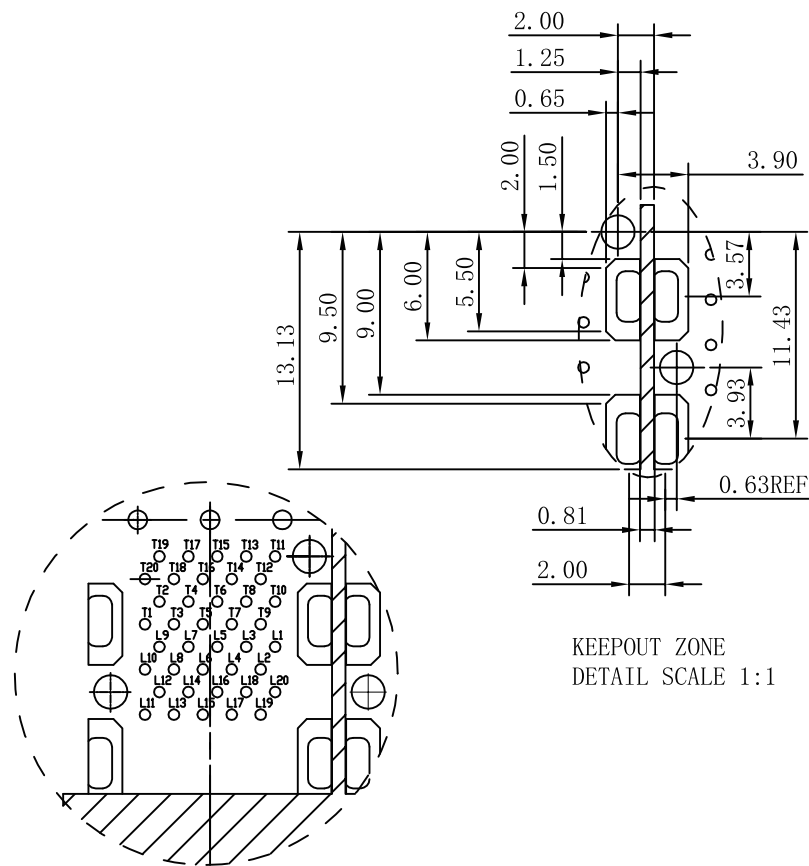

CONNECTOR PIN-OUT
COMPONENT SIDE OF BOARD

RoHS Compliant



苏州沃虎电子科技有限公司
Su Zhou Voohu Electronic Tech.Co.Ltd

TITLE:
SFP 2X8 CONNECTOR

SIZE
A4
UNITS
MM[INCH]

GENERAL TOLERANCES
UNLESS SPECIFIED

APPROVED BY:
Geoffrey. Song

PART NO.:
WHSFP06228D008

SACLE
1:1
REV
A0

$x \pm 0.35$	$x^\circ \pm 3.0^\circ$
$.x \pm 0.30$	$.x^\circ \pm 2.0^\circ$

CHECKED BY:
Elvis. Song

REMARK:
Gold plated 15u"

SHEET
1/4

$.xx \pm 0.25$	$.xx^\circ \pm 1.5^\circ$
$.xxx \pm 0.10$	$.xxx^\circ \pm 1.0^\circ$

DESIGN BY:
Sunny. Xu

TEL: +86 400 1048 018

WEB: WWW.WOHU-TEK.COM