

REACH & RoHS  
COMPLIANT

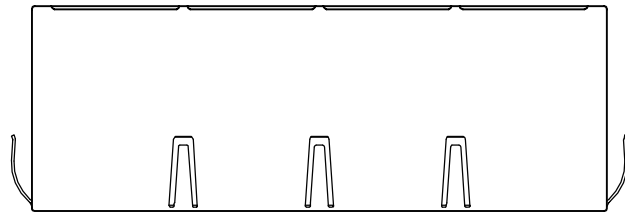

TOP VIEW

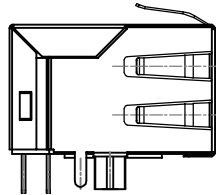

LEFT SIDE VIEW

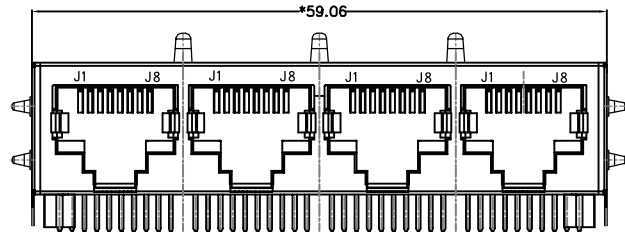

FRONT VIEW

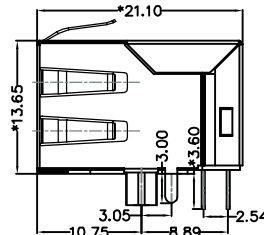

RIGHT SIDE VIEW

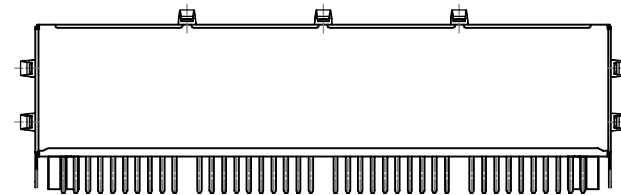

BACK VIEW

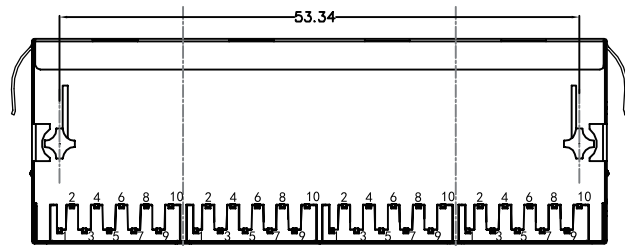

BOTTOM VIEW

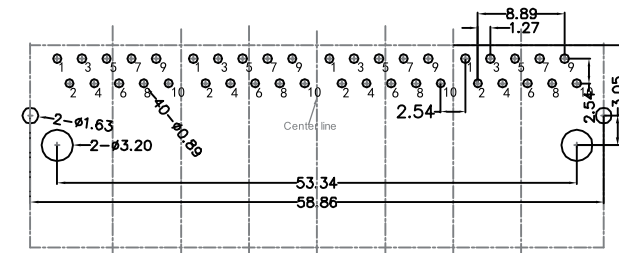

RECOMMENDED PCB LAYOUT  
VIEWED FROM COMPONENT SIDE

**MATERIAL:**  
HOUSING: PBT,UL94V-0,BLACK.  
TERMINALS BRACKET: PBT,UL94V-0,BLACK.  
SHIELD: C2680,T=0.20MM,NICKEL PLATING ON ALL AREA.  
TERMINAL: PHOSPHOR BRONZE C5210,T=0.35MM,  
6U" GOLD PLATING ON CONTACT AREA.

**MECHANICAL:**  
DURABILITY: 750 CYCLES MIN.  
MATING FORCE: 23N MAX.  
OPERATING TEMPERATURE: -40°C~+85°C.  
STORAGE TEMPERATURE: -40°C~+85°C.  
ALL CRITICAL DIMENSIONS WITH "±"

 沃虎 苏州沃虎电子科技有限公司  
VOOHU Su Zhou Voohu Electronic Tech.Co.Ltd

TITLE:  
TAB-DOWN 1×4 1000BASE

SIZE  
A4

UNITS  
MM[INCH]

GENERAL TOLERANCES  
UNLESS SPECIFIED

PART NO.:  
SYT114Q070HWA1D

SACLE  
1:1

REV  
A0

$x \pm 0.35$   $x^\circ \pm 3.0^\circ$   
 $.x \pm 0.30$   $.x^\circ \pm 2.0^\circ$

CHECKED BY:  
Elvis.Song

TEL: +86 400 1048 018

WEB: [WWW.WOHU-TEK.COM](http://WWW.WOHU-TEK.COM)

REMARK:

SHEET  
1/4



$.xx \pm 0.25$   $.xx^\circ \pm 1.5^\circ$   
 $.xxx \pm 0.10$   $.xxx^\circ \pm 1.0^\circ$

DESIGND BY:  
Sunny.Xu

REACH & RoHS  
COMPLIANT

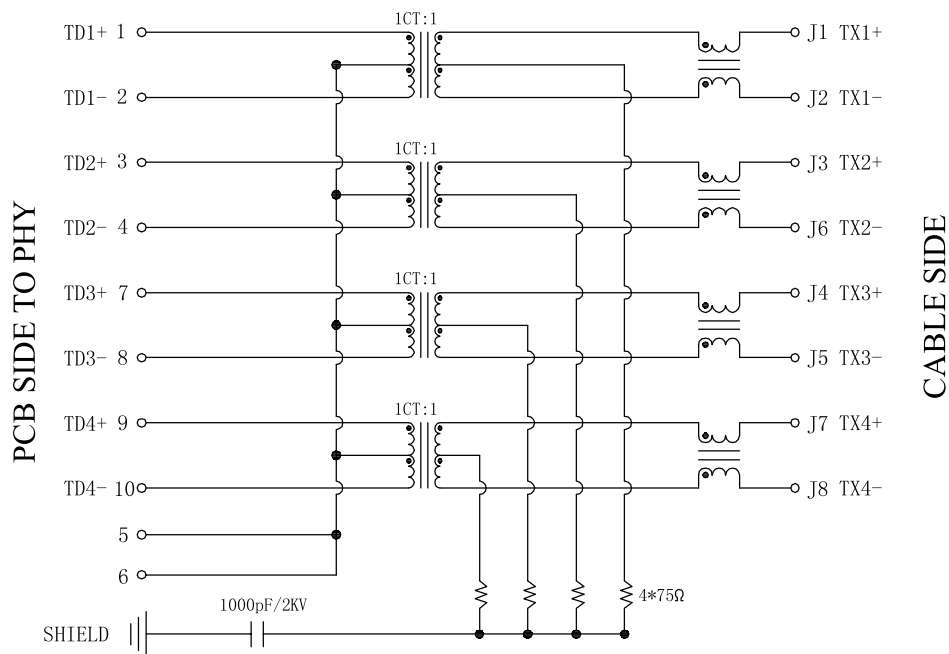

**Electrical:**

1. Turn ratio: 1~2: J1~J2=1CT:1CT(±2%).  
3~4: J3~J6=1CT:1CT(±2%).  
7~8: J4~J5=1CT:1CT(±2%).  
9~10: J7~J8=1CT:1CT(±2%).
2. OCL: 350uH Min. at 100KHz 100mV 8mA DC.
3. Insertion Loss: -1.0 dB Max 1~100MHz.
4. Return loss: -18dB Min 1~30MHz;  
-14dB Min 30~60MHz.  
-12dB Min 60~80MHz.  
-10dB Min 80~100MHz.
5. Cross talk: -40dB Min 1~30MHz;  
-35dB Min 30~60MHz;  
-30dB Min 60~100MHz;
6. CMR: -30dB Min 1~100MHz;
7. Hi-Pot: 2250V DC 6S 1mA PRI TO SEC

 沃虎 苏州沃虎电子科技有限公司  
VOOHU Su Zhou Voohu Electronic Tech.Co.Ltd

TITLE:  
TAB-DOWN 1×4 1000BASE

SIZE  
A4

UNITS  
MM[INCH]

GENERAL TOLERANCES  
UNLESS SPECIFIED

PART NO.:  
SYT114Q070HWA1D

SACLE  
1:1

REV  
A0

x±0.35	x°±3.0°
.x±0.30	.x°±2.0°

CHECKED BY:  
Elvis.Song

TEL: +86 400 1048 018

WEB: [WWW.WOHU-TEK.COM](http://WWW.WOHU-TEK.COM)

REMARK:

SHEET  
1/4



.xx±0.25	.xx°±1.5°
.xxx±0.10	.xxx°±1.0°

DESIGND BY:  
Sunny.Xu

REACH & RoHS  
COMPLIANT

# PROFILE OF WAVE SOLDER

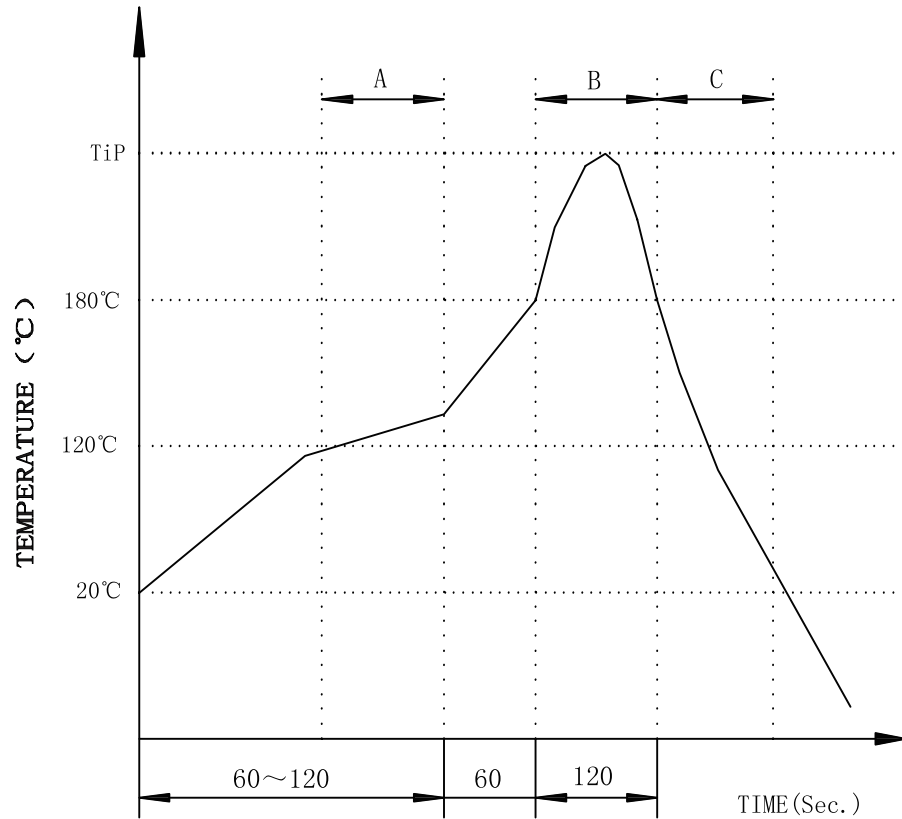

A.Preheating B.Soldering C.Gradual Cooling  
 Tip temperature:260±5°C.  
 Tip temperature time:5Sec Max.  
 Tip melting point of Sn96.5/Ag3/Cu0.5:217°C.

Remarks: after wave soldering, the plastic positioning columns of the product which under the PCB will be slightly melted, but it won't affect its function.

 **沃虎** 苏州沃虎电子科技有限公司  
 VOOHU Su Zhou Voohu Electronic Tech.Co.Ltd

TITLE:  
TAB-DOWN 1×4 1000BASE

SIZE  
A4

UNITS  
MM[INCH]

GENERAL TOLERANCES  
UNLESS SPECIFIED

APPROVED BY:  
Geoffrey.Song

PART NO.:  
SYT114Q070HWA1D

SACLE  
1:1

REV  
A0

$x \pm 0.35$   $x^\circ \pm 3.0^\circ$   
 $.x \pm 0.30$   $.x^\circ \pm 2.0^\circ$

CHECKED BY:  
Elvis.Song

TEL: +86 400 1048 018

WEB: [WWW.WOHU-TEK.COM](http://WWW.WOHU-TEK.COM)

REMARK:

SHEET  
1/4

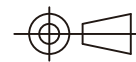

$.xx \pm 0.25$   $.xx^\circ \pm 1.5^\circ$   
 $.xxx \pm 0.10$   $.xxx^\circ \pm 1.0^\circ$

DESIGND BY:  
Sunny.Xu