

REACH & RoHS
COMPLIANT

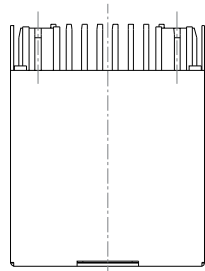

TOP VIEW

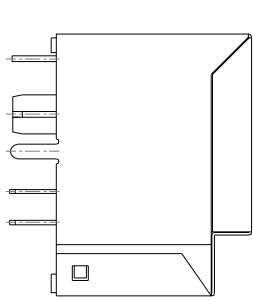

LEFT SIDE VIEW

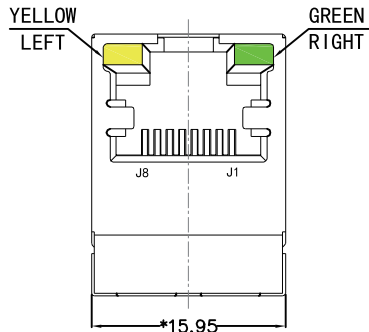

FRONT VIEW

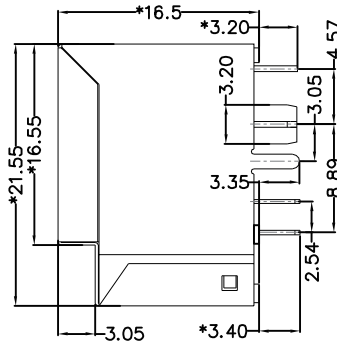

RIGHT SIDE VIEW

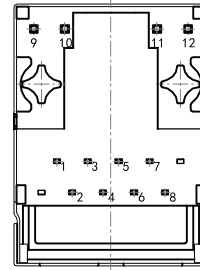

BACK VIEW

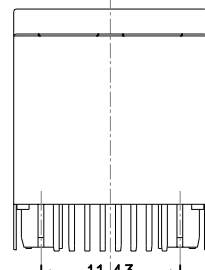

BOTTOM VIEW

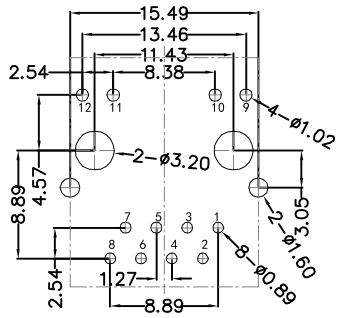

RECOMMENDED PCB LAYOUT
VIEWED FROM COMPONENT SIDE

MATERIAL:

HOUSING: PBT,UL94V-0,BLACK.
TERMINALS BRACKET: PBT,UL94V-0,BLACK.
SHIELD: C2680,T=0.20MM,NICKEL PLATING ON ALL AREA.
TERMINAL: PHOSPHOR BRONZE C5210,T=0.35MM,
6U" GOLD PLATING ON CONTACT AREA.

MECHANICAL:

DURABILITY: 750 CYCLES MIN.
MATING FORCE: 23N MAX.
OPERATING TEMPERATURE: -40°C~+85°C.
STORAGE TEMPERATURE: -40°C~+85°C.
ALL CRITICAL DIMENSIONS WITH "*"

 沃虎 苏州沃虎电子科技有限公司
VOOHU Su Zhou Voohu Electronic Tech.Co.Ltd

TITLE:
TAB-UP 1×1 100BASE

SIZE
A4

UNITS
MM[INCH]

GENERAL TOLERANCES
UNLESS SPECIFIED

APPROVED BY:
Geoffrey.Song

PART NO.:
SYT511B002AA1A1D068-帶缺口

SACLE
1:1

REV
A0

x±0.35	x°±3.0°
.x±0.30	.x°±2.0°

CHECKED BY:
Elvis.Song

TEL: +86 400 1048 018

WEB: WWW.WOHU-TEK.COM

REMARK:

SHEET
1/4

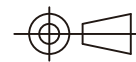

.xx±0.25	.xx°±1.5°
.xxx±0.10	.xxx°±1.0°

DESIGND BY:
Sunny.Xu

REACH & RoHS
COMPLIANT

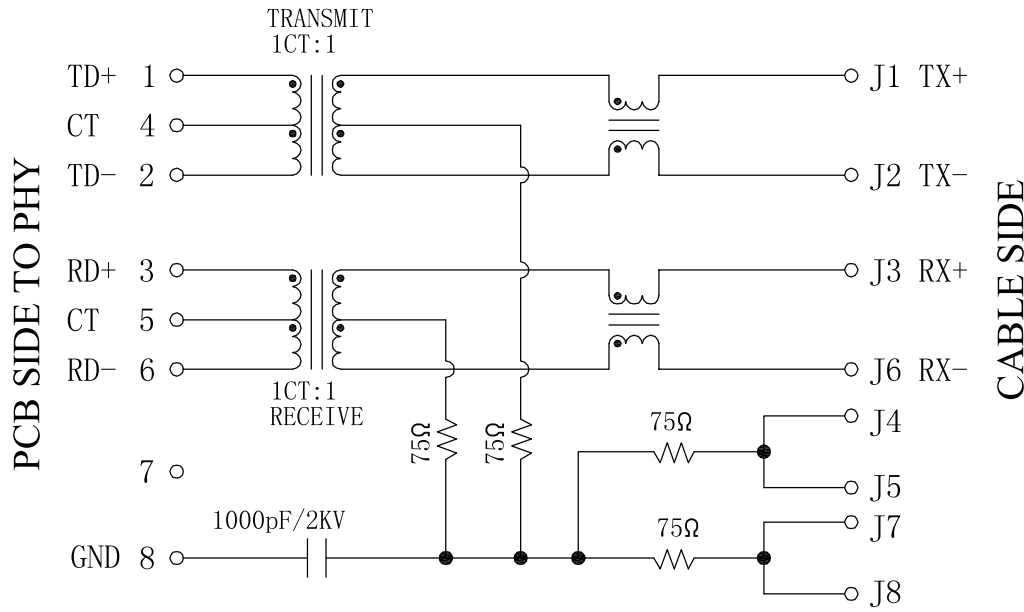

Electrical:

- Turn ratio: 1~2: J1~J2 = 1CT:1CT(±2%).
3~6: J3~J6 = 1CT:1CT(±2%).
- OCL: 350uH Min. at 100KHz 100mV 8mA DC.
- Insertion Loss: -1.0 dB Max 1~100MHz.
- Return loss: -20dB Min 1~10MHz;
-1 6dB Min 10~30MHz.
-1 2dB Min 30~60MHz.
-10dB Min 60~80MHz.
- Cross talk: -40dB Min 1~30MHz;
-35dB Min 30~60MHz;
-30dB Min 60~100MHz;
- CMR: -35dB Min 1~100MHz;
- Hi-Pot: 1500V AC & 2250V DC
6S 1mA PRI TO SEC

LED Specification

Standard LED Color	LED Wavelength	Foward(A)	Foward(V)
Green	568nm	20mA	1.85-2.45V
Yellow	585nm	20mA	1.7-2.2V

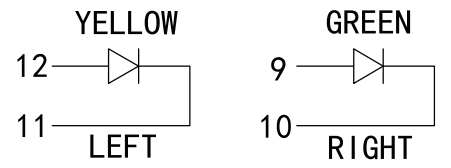

 **沃虎 苏州沃虎电子科技有限公司**
Su Zhou Voohu Electronic Tech.Co.Ltd

TITLE: TAB-UP 1×1 100BASE
SIZE A4
UNITS MM[INCH]
GENERAL TOLERANCES UNLESS SPECIFIED
APPROVED BY: Geoffrey.Song

PART NO.: SYT511B002AA1A1D068-带缺口
SACLE 1:1
REV A0
CHECKED BY: Elvis.Song

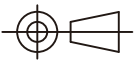
REMARK:
SHEET 1/4

DESIGND BY: Sunny.Xu

TEL: +86 400 1048 018 [WEB: WWW.WOHU-TEK.COM](http://WWW.WOHU-TEK.COM)

REACH & RoHS
COMPLIANT

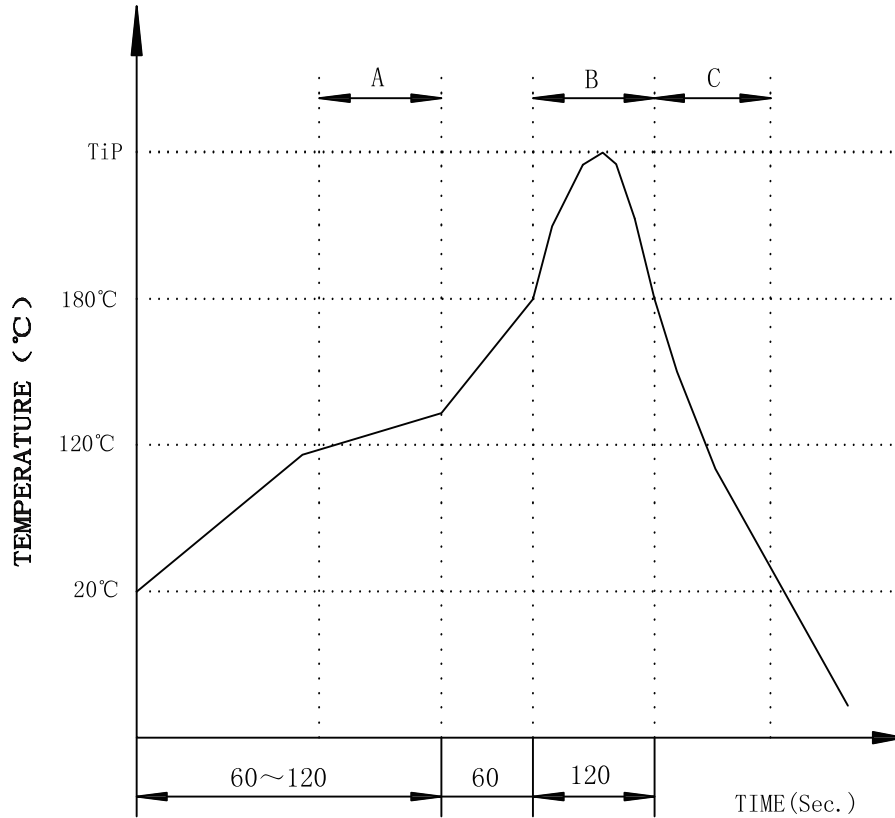
PROFILE OF WAVE SOLDER



A.Preheating B.Soldering C.Gradual Cooling
 Tip temperature:260±5°C.
 Tip temperature time:5Sec Max.
 Tip melting point of Sn96.5/Ag3/Cu0.5:217°C.

Remarks: after wave soldering, the plastic positioning columns of the product which under the PCB will be slightly melted, but it won't affect its function.

 **沃虎** 苏州沃虎电子科技有限公司
 VOOHU Su Zhou Voohu Electronic Tech.Co.Ltd

TITLE:
TAB-UP 1×1 100BASE

SIZE
A4

UNITS
MM[INCH]

GENERAL TOLERANCES
UNLESS SPECIFIED

APPROVED BY:
Geoffrey.Song

PART NO.:
SYT511B002AA1A1D068-帶缺口

SACLE
1:1

REV
A0

x±0.35	x°±3.0°
.x±0.30	.x°±2.0°

CHECKED BY:
Elvis.Song

TEL: +86 400 1048 018

WEB: WWW.WOHU-TEK.COM

REMARK:

SHEET
1/4



.xx±0.25	.xx°±1.5°
.xxx±0.10	.xxx°±1.0°

DESIGND BY:
Sunny.Xu