

APPROVED SHEET

CUSTOMER: _____

CUSTOMER P/N: _____

JWD P/N: S16037T G

REV: R0

DESCRIPTION: 10/100 BASE-TX

CUSTOMER APPROVAL		COMPANY APPROVAL	
INSPECTED BY:		ISSUED BY:	Sea
CHECKED BY:		CHECKED BY:	
APPROVED BY:		APPROVED BY:	
APPROVED DATE:		ISSUED DATE:	2020/11/2

Please Return One Copy to Us After Approved,TKS! (承认后请回寄一份,谢谢)



四川经纬达科技集团有限公司

Sichuan Jingweida Technology Group Co., Ltd

地址: 绵阳高新区防震减灾产业园

ADD: Protecting Against and Mitigating Earthquake Disasters Industrial Park,

High-tech Zone, Mianyang, Sichuan 621000 CHINA.

TEL: +86-816-2561202 FAX: +86-816-2562518

E-MAIL: myjwd@myjwd.com

WEB: www.myjwd.com



四川经纬达科技集团有限公司

Sichuan Jingweida Technology Group Co., Ltd

A. MECHANICAL(unit:mm)

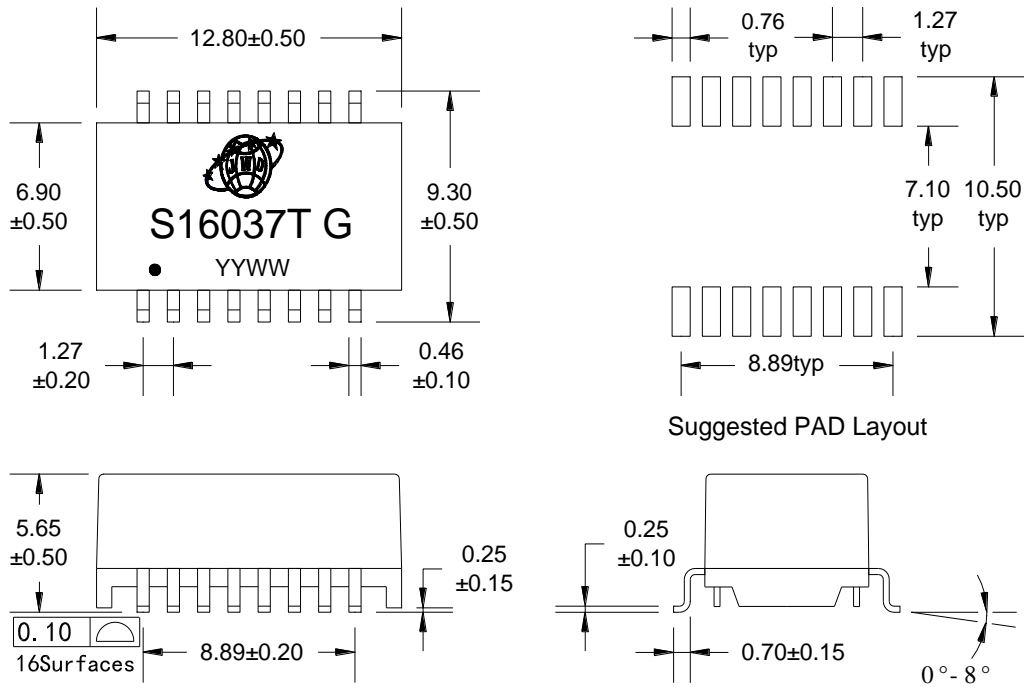

B. SCHEMATICS

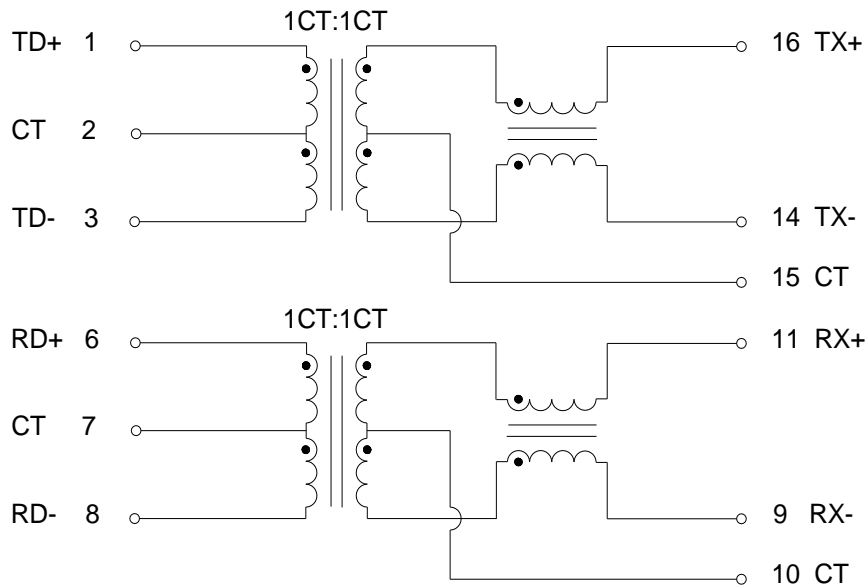

DESCRIPTION	JWD P/N	SPEC NO.	REV: R0
10/100 BASE-TX	S16037T G		PAGE: 1/3



四川经纬达科技集团有限公司

Sichuan Jingweida Technology Group Co., Ltd

C. ELECTRICAL SPECIFICATIONS @25°C

1. OCL: 350uH Min @ 100 KHz, 0.1V with 8mA DC BIAS
2. Leakage Inductance: 0.5uH Max @ 100KHz, 0.1V
3. DCR: 1400mΩ Max
4. Turns Ratio: 1CT:1CT±5%
5. Insertion Loss: -1.1 dB Max @ 1-100 MHz
6. Return Loss: -18 dB Min @ 1-30 MHz
 - 14.4 dB Min @ 40 MHz
 - 13.1 dB Min @ 50 MHz
 - 12 dB Min @ 60-80 MHz
7. Cross Talk: -30 dB Min @ 1-100 MHz
8. Common Mode Rejection: -30 dB Min @ 1-100 MHz
9. Isolation Hipot: 1500VAC 1mA 60S
10. Operating temperature -40°C to +85°C
11. Storage temperature -40°C to +85°C

DESCRIPTION	JWD P/N	SPEC NO.	REV: R0
10/100 BASE-TX	S16037T G		PAGE: 2/3



四川经纬达科技集团有限公司

Sichuan Jingweida Technology Group Co., Ltd

D. PACKAGE INFORMATION

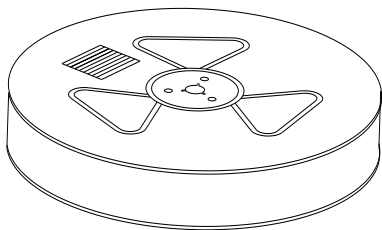
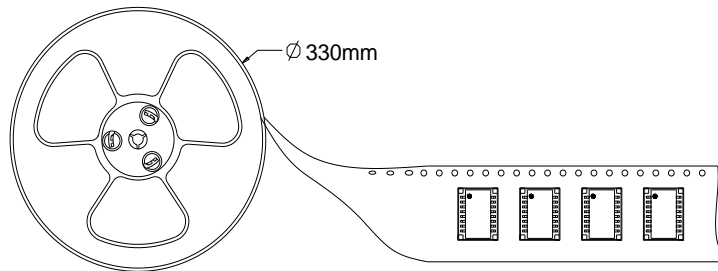
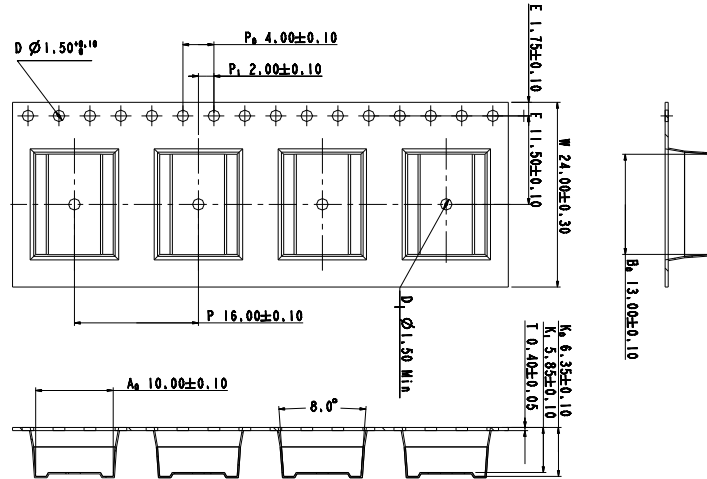

Three Reel

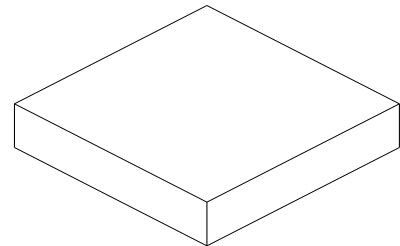

Inner Carton

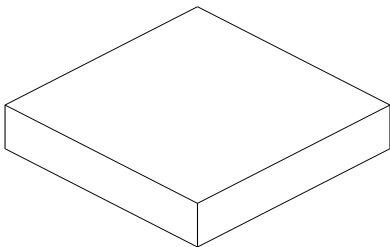

Two Inner Carton

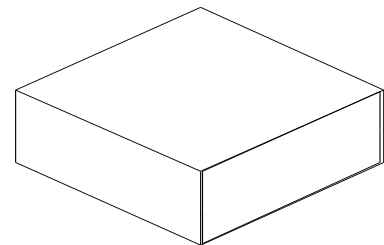

Export Carton

Package Quantity:

One Reel=600Pcs

One Inner Carton=600*3=1800Pcs

One Export Carton=1800*2=3600Pcs

DESCRIPTION	JWD P/N	SPEC NO.	REV: R0
10/100 BASE-TX	S16037T G		PAGE: 3/3