

APPROVED SHEET

CUSTOMER: _____

CUSTOMER P/N: _____

JWD P/N: _____

D12501 G

REV: _____

R1

DESCRIPTION: _____

10/100 BASE-TX

CUSTOMER APPROVAL		COMPANY APPROVAL	
INSPECTED BY:		ISSUED BY:	Linn
CHECKED BY:		CHECKED BY:	
APPROVED BY:		APPROVED BY:	
APPROVED DATE:		ISSUED DATE:	2021/4/12

Please Return One Copy to Us After Approved,TKS! (承认后请回寄一份,谢谢)

四川经纬达科技集团有限公司

Sichuan Jingweida Technology Group Co., Ltd

地址: 四川省绵阳市高新区永兴镇永兴工业园

ADD: YongXing Industrial of High-tech Zone In Mianyang City,

Sichuan Province

TEL: +86-816-2561202 FAX: +86-816-2562518

E-MAIL: myjwd@myjwd.com

WEB: www.myjwd.com





四川经纬达科技集团有限公司

Sichuan Jingweida Technology Group Co., Ltd

A. MECHANICAL(unit:mm)

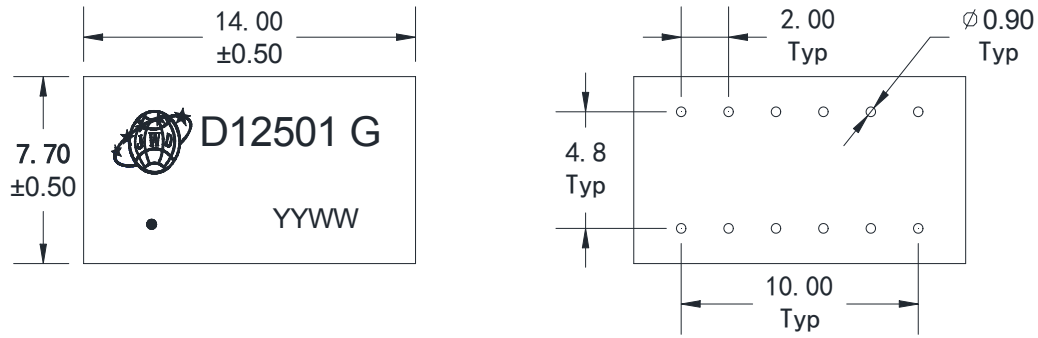

SUGGESTED PAD LAYOUT

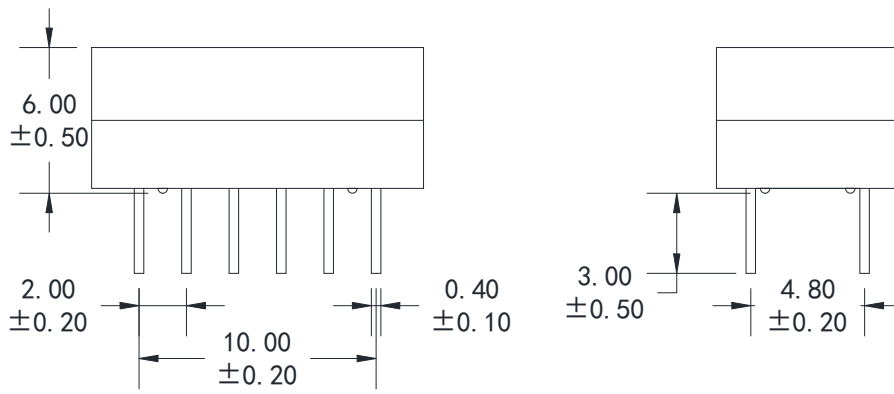

B. SCHEMATICS

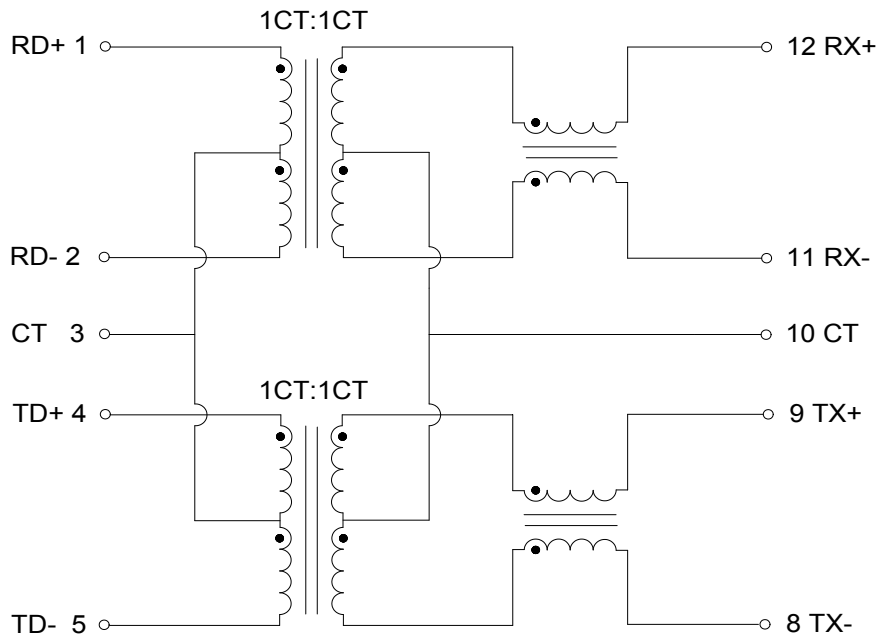

DESCRIPTION	JWD P/N	SPEC NO.	REV: R1
10/100 BASE-TX	D12501 G		PAGE: 1/3



四川经纬达科技集团有限公司

Sichuan Jingweida Technology Group Co., Ltd

C. ELECTRICAL SPECIFICATIONS @25°C

1. OCL: 350uH Min @ 100KHz, 0.1V 8mA DC BIAS
2. Leakage Inductance: 0.5uH Max @ 100KHz, 0.1V
3. DCR: 1400mΩ Max
4. Turns Ratio: 1CT:1CT±5%
5. Insertion Loss: -1.1 dB Max @ 1-100 MHz
6. Return Loss: -18 dB Min @ 1-30 MHz
-14.4 dB Min @ 40 MHz
-13.1 dB Min @ 50 MHz
-12 dB Min @ 60-80 MHz
7. Cross Talk: -30 dB Min @ 1-100 MHz
8. Common Mode Rejection: -30 dB Min @ 1-100 MHz
9. Isolation Hipot: 1500VAC 1mA 60S
10. Operating temperature 0°C to +70°C
11. Storage temperature -40°C to +85°C

DESCRIPTION	JWD P/N	SPEC NO.	REV: R1
10/100 BASE-TX	D12501 G		PAGE: 2/3



四川经纬达科技集团有限公司

Sichuan Jingweida Technology Group Co., Ltd

D. PACKAGE INFORMATION

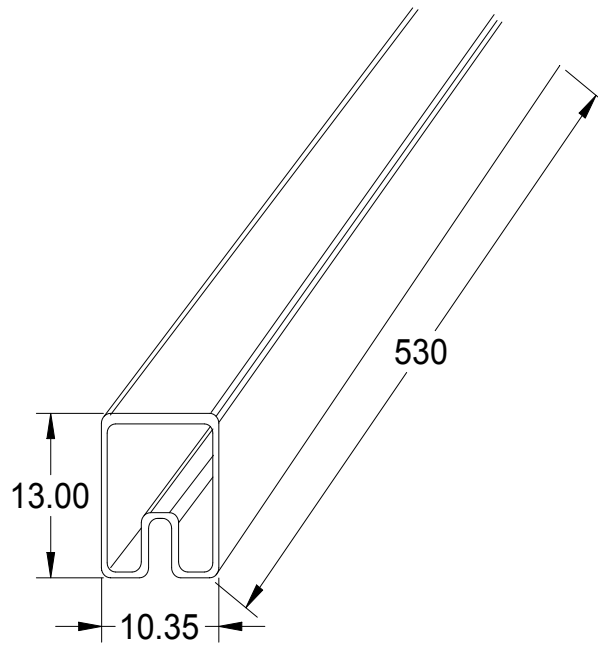

Tube: 535*13.0*10.35mm

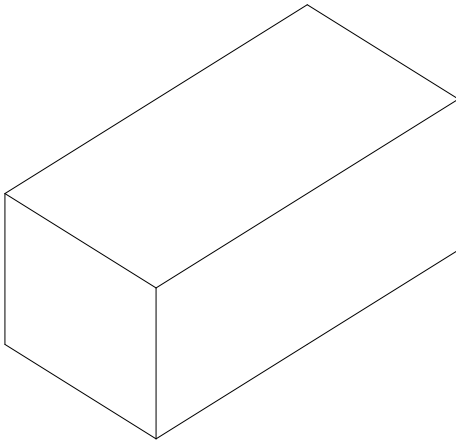

Inner Carton: L570*W180*H100mm

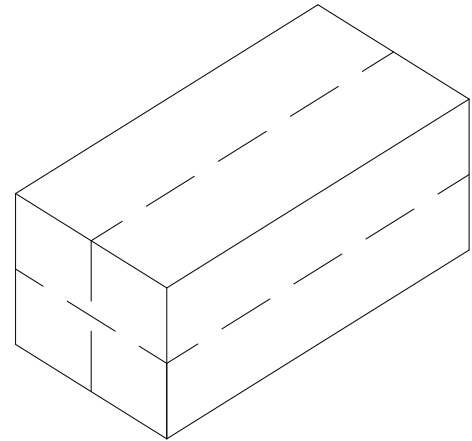

Export Carton: L580*W380*H240mm

Package Quantity:

One Tube=36Pcs

One Inner Carton=3240Pcs

One Export Carton=12960Pcs

DESCRIPTION	JWD P/N	SPEC NO.	REV: R1
10/100 BASE-TX	D12501 G		PAGE: 3/3