

APPROVED SHEET

CUSTOMER: _____

CUSTOMER P/N: _____

JWD P/N: _____

S160B1 G

REV: _____

R0

DESCRIPTION: _____

10/100 BASE-TX

CUSTOMER APPROVAL		COMPANY APPROVAL	
INSPECTED BY:		ISSUED BY:	Chengkun, Li
CHECKED BY:		CHECKED BY:	
APPROVED BY:		APPROVED BY:	
APPROVED DATE:		ISSUED DATE:	2019/5/30

Please Return One Copy to Us After Approved,TKS! (承认后请回寄一份,谢谢)



四川经纬达科技集团有限公司

Sichuan Jingweida Technology Group Co., Ltd

地址: 四川省绵阳市高新区永兴镇永兴工业园

ADD: YongXing Industrial of High-tech Zone In Mianyang City, Sichuan Province

TEL: +86-816-2561202 FAX: +86-816-2562518

E-MAIL: myjwd@myjwd.com

WEB: www.myjwd.com



四川经纬达科技集团有限公司

Sichuan Jingweida Technology Group Co., Ltd

A. MECHANICAL(unit:mm)

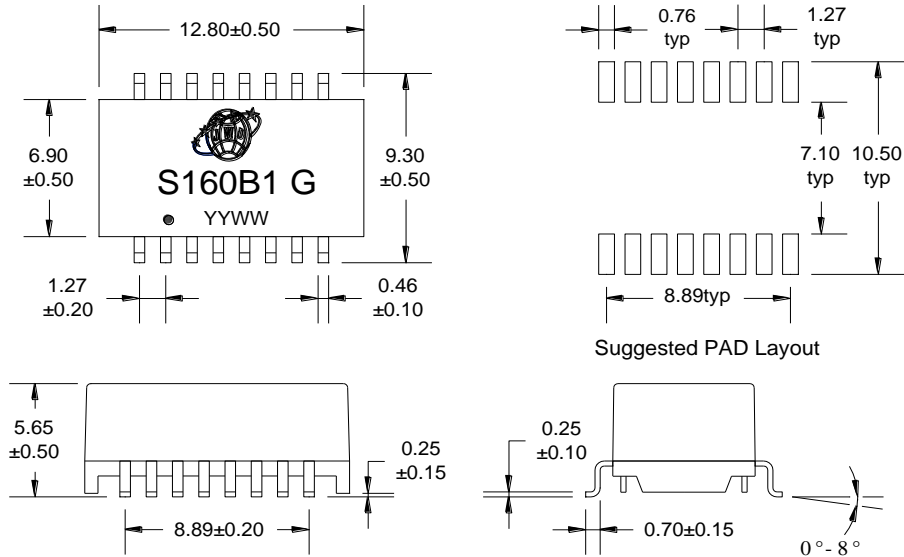

B. SCHEMATICS

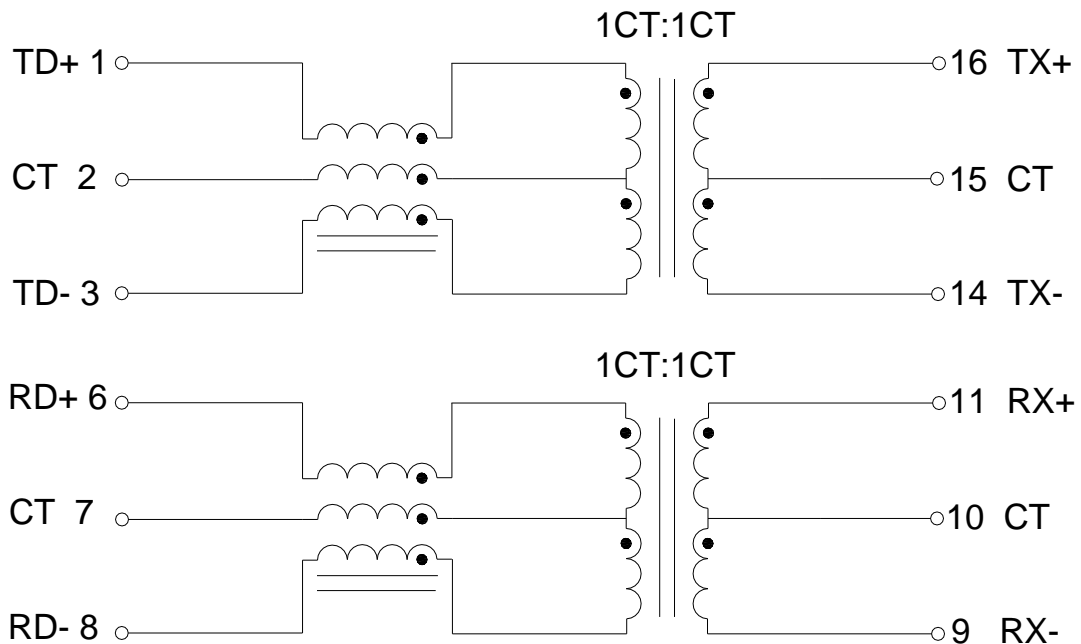

DESCRIPTION	JWD P/N	SPEC NO.	REV: R0
10/100 BASE-TX	S160B1 G		PAGE: 1/3



四川经纬达科技集团有限公司

Sichuan Jingweida Technology Group Co., Ltd

C. ELECTRICAL SPECIFICATIONS @25°C

1. OCL: 350uH Min @ 100 KHz, 0.1V with 8mA DC BIAS
2. Leakage Inductance: 0.5uH Max @ 100KHz, 0.1V
3. DCR: 1400mΩ Max
4. Turns Ratio: 1CT:1CT±5%
5. Insertion Loss: -1.2 dB Max @ 0.5-1 MHz
-0.2-0.002*f^{1.4} dB Max @ 1-125 MHz
6. Return Loss: -16 dB Min @ 1-40 MHz
-10+20*log (f/80) dB Min @ 40.1-100 MHz
7. Cross Talk: -30 dB Min @ 1-100 MHz
8. Common Mode Rejection: -30 dB Min @ 1-100 MHz
9. Isolation Hipot: 1500VAC 1mA 60S
10. Operating temperature 0°C to +70°C
11. Storage temperature -40°C to +85°C

DESCRIPTION	JWD P/N	SPEC NO.	REV: R0
10/100 BASE-TX	S160B1 G		PAGE: 2/3



四川经纬达科技集团有限公司

Sichuan Jingweida Technology Group Co., Ltd

D. PACKAGE INFORMATION

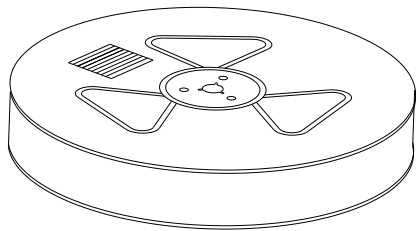
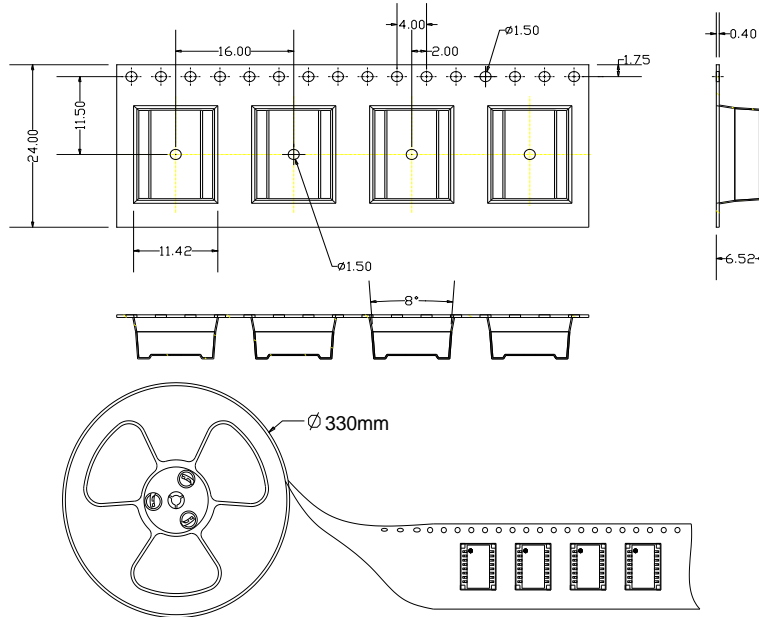

three reel

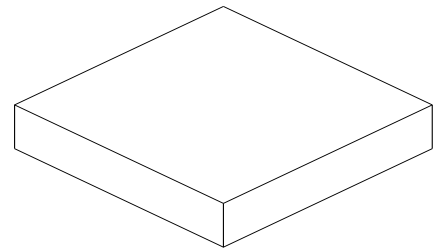

Inner Carton

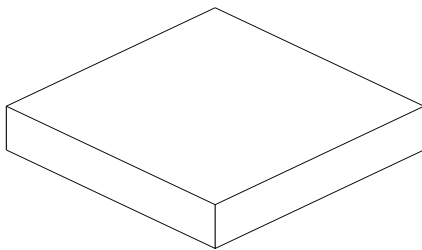

two Inner Carton

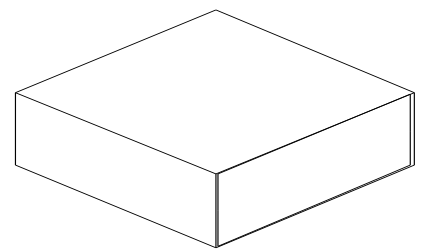

Export Carton

Package Quantity:

One Reel=600Pcs

One Inner Carton=600*3=1800Pcs

One Export Carton=1800*2=3600Pcs

DESCRIPTION	JWD P/N	SPEC NO.	REV: R0
10/100 BASE-TX	S160B1 G		PAGE: 3/3