

**A. MECHANICAL (unit:mm)**

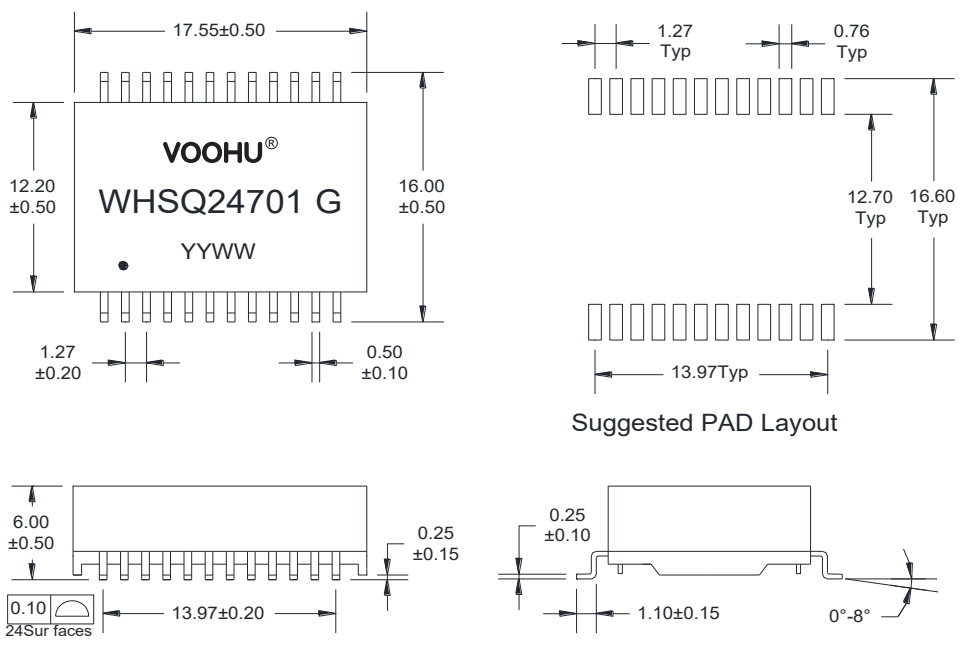

**B. SCHEMATICS**

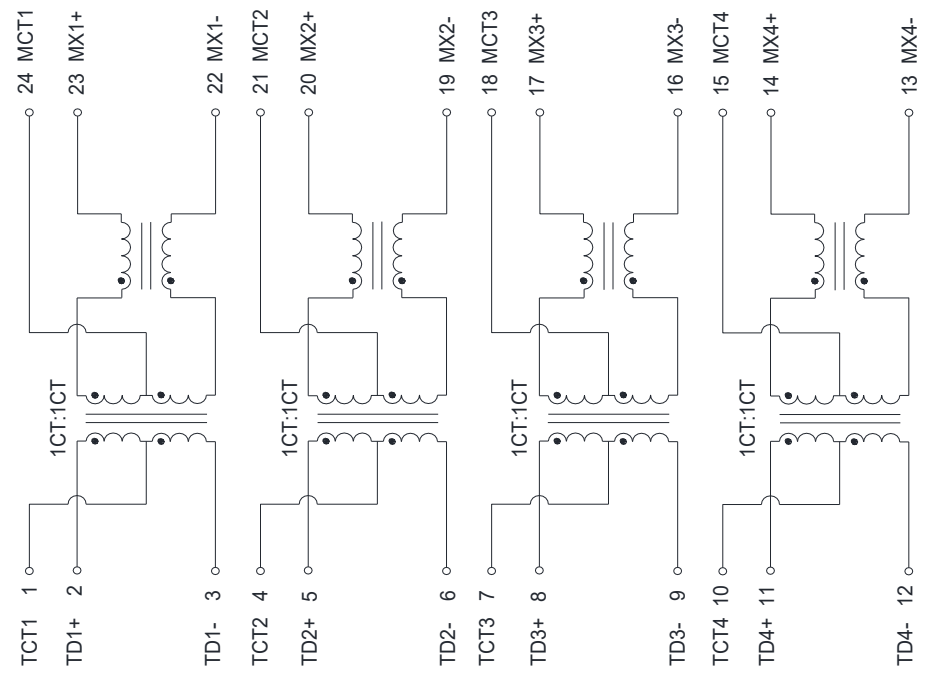

**VOOHU** 苏州沃虎电子科技有限公司  
Su Zhou Voohu Electronic Tech.Co.Ltd

TITLE:  
2.5/5G BASE-T

SIZE  
A4

UNITS  
MM[INCH]

GENERAL TOLERANCES  
UNLESS SPECIFIED

APPROVED BY:  
Geoffrey.Song

PART NO.:  
WHSQ24701 G

SACLE  
1:1

REV  
A0

$x \pm 0.35$	$x^\circ \pm 3.0^\circ$
$.x \pm 0.30$	$.x^\circ \pm 2.0^\circ$
$.xx \pm 0.25$	$.xx^\circ \pm 1.5^\circ$
$.xxx \pm 0.10$	$.xxx^\circ \pm 1.0^\circ$

CHECKED BY:  
Elvis.Song

TEL: +86 400 1048 018

WEB: [WWW.WOHU-TEK.COM](http://WWW.WOHU-TEK.COM)

REMARK:

SHEET  
1/3

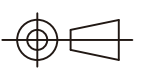

DESIGND BY:  
Sunny.Xu

## D. ELECTRICAL SPECIFICATIONS @25°C

1. OCL: 200uH Min @ 100KHz, 0.1V
2. Leakage Inductance: 0.5uH Max @ 100KHz, 0.1V
3. DCR: 1000mΩ Max
4. Turns Ratio: 1CT:1CT±5%
5. Insertion Loss: -1.0 dB Max @ 1-100 MHz  
-2.0 dB Max @ 100-250 MHz
6. Return Loss: -16 dB Min @  $1 \leq f \leq 40$  MHz  
-16+10log(f/40) dB Min @  $40 < f \leq 250$  MHz,  
where f is in MHz
7. Cross Talk: -30 dB Typ @ 1-250 MHz
8. Common Mode Rejection Ratio: -30 dB Typ @ 1-250 MHz
9. Isolation Hipot: 1500VAC 1mA 60S
10. Operating temperature 0°C to +70°C
11. Storage temperature -45°C to +125°C

## E. PACKAGE INFORMATION

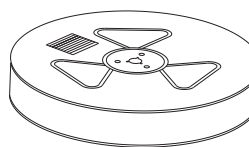
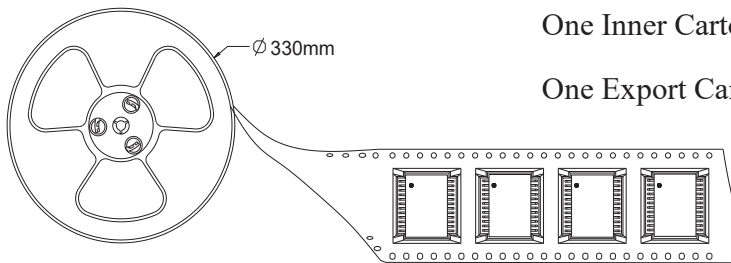
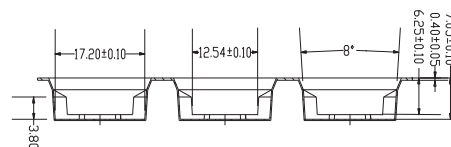
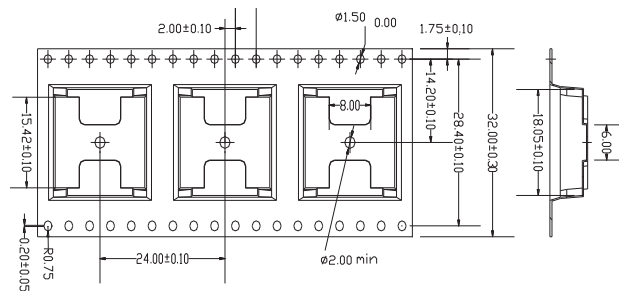

two reel

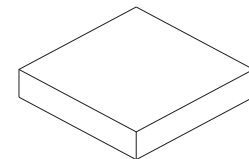

five Inner Carton

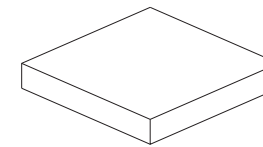

Inner Carton

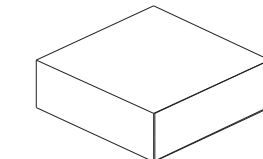

Export Carton

Package Quantity:

One Reel=350Pcs

One Inner Carton=350\*2=700Pcs

One Export Carton=700\*5=3500Pcs

**VOOHU** 苏州沃虎电子科技有限公司  
Su Zhou Voohu Electronic Tech.Co.Ltd

TITLE:  
2.5/5G BASE-T

SIZE  
A4

UNITS  
MM[INCH]

GENERAL TOLERANCES  
UNLESS SPECIFIED

APPROVED BY:  
Geoffrey.Song

PART NO.:  
WHSQ24701 G

SACLE  
1:1

REV  
A0

$x \pm 0.35$   
 $.x \pm 0.30$   
 $.xx \pm 0.25$   
 $.xxx \pm 0.10$

$x^\circ \pm 3.0^\circ$   
 $.x^\circ \pm 2.0^\circ$   
 $.xx^\circ \pm 1.5^\circ$   
 $.xxx^\circ \pm 1.0^\circ$

CHECKED BY:  
Elvis.Song  
DESIGND BY:  
Sunny.Xu

TEL: +86 400 1048 018

WEB: [WWW.WOHU-TEK.COM](http://WWW.WOHU-TEK.COM)

REMARK:

SHEET  
2/3

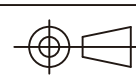

H

G

F

E

D

C

B

A

H

G

F

E

D

C

B

A

F. RECOMMEND REFLOW SOLDERING CURVE

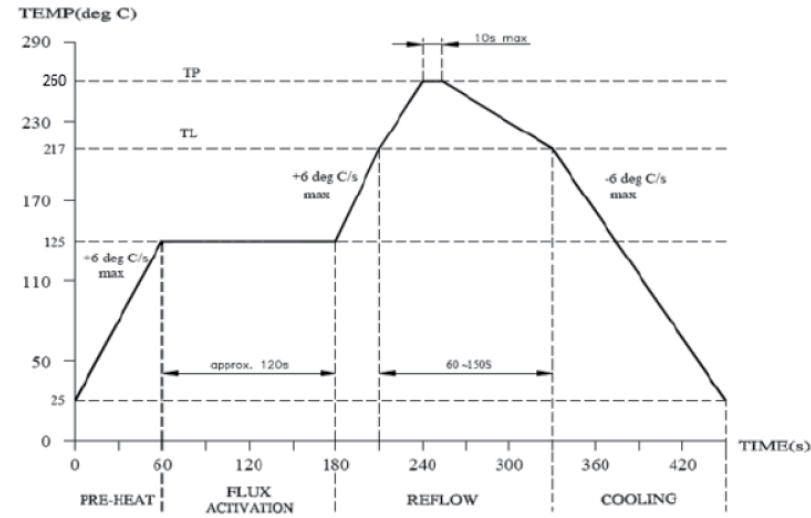

**VOOHU** 苏州沃虎电子科技有限公司  
Su Zhou Voohu Electronic Tech.Co.Ltd

TEL: +86 400 1048 018      WEB: WWW.WOHU-TEK.COM

TITLE:  
2. 5/5G BASE-T

PART NO.:  
WHSQ24701 G

REMARK:

SIZE  
A4

SACLE  
1:1

SHEET  
3/3

UNITS  
MM[INCH]

REV  
A0

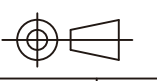

GENERAL TOLERANCES  
UNLESS SPECIFIED

x±0.35	x°±3.0°
.x±0.30	.x°±2.0°

.xx±0.25	.xx°±1.5°
.xxx±0.10	.xxx°±1.0°

APPROVED BY:  
Geoffrey.Song

CHECKED BY:  
Elvis.Song

DESIGND BY:  
Sunny.Xu