

A. MECHANICAL(unit:mm)

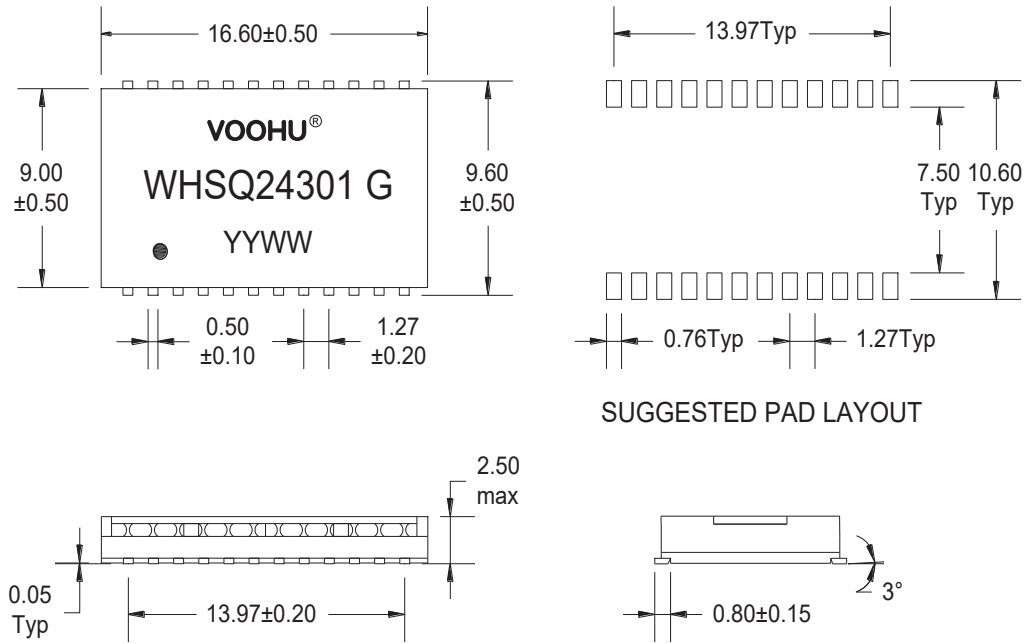

B. SCHEMATICS

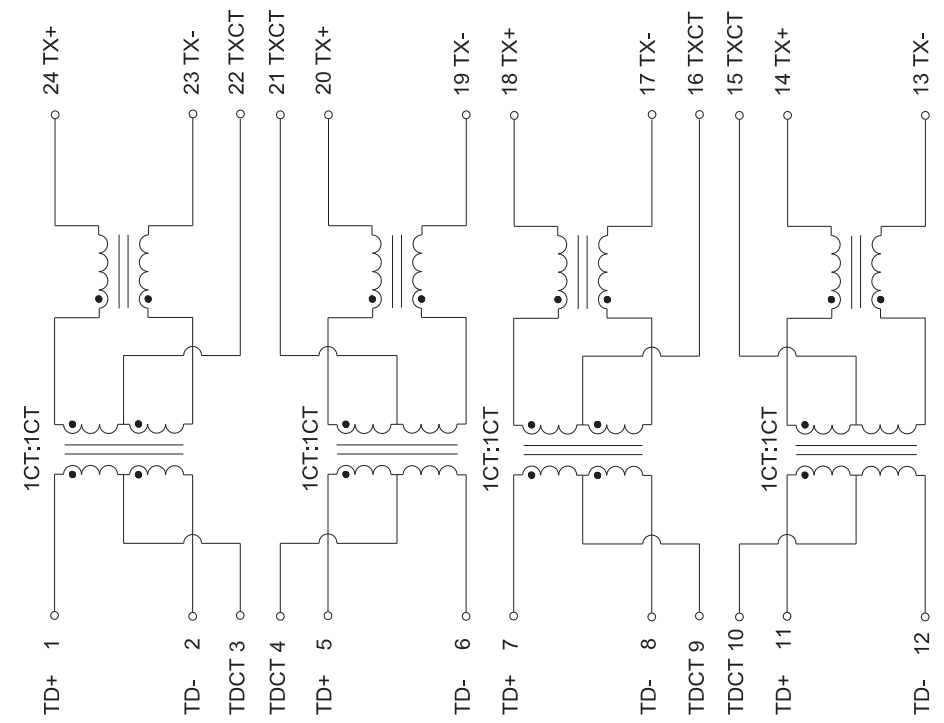

VOOHU 苏州沃虎电子科技有限公司
Su Zhou Voohu Electronic Tech.Co.Ltd

TITLE:
2.5/5GBASE-T

SIZE
A4

UNITS
MM[INCH]

GENERAL TOLERANCES
UNLESS SPECIFIED

PART NO.:
WHSQ24301 G

SACLE
1:1

REV
A0

$x \pm 0.35$
 $.x \pm 0.30$

APPROVED BY:
Geoffrey.Song
CHECKED BY:
Elvis.Song

TEL: +86 400 1048 018
WEB: WWW.WOHU-TEK.COM

REMARK:

SHEET
1/2

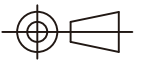

$.xx \pm 0.25$
 $.xxx \pm 0.10$

DESIGND BY:
Sunny.Xu

C. ELECTRICAL SPECIFICATIONS @25°C

1. OCL: 180uH Min @ 100KHz, 0.1V
2. Leakage Inductance: 0.5uH Max @ 100KHz, 0.1V
3. DCR: 1000mΩ Max
4. Turns Ratio: 1CT:1CT±5%
5. Insertion Loss: -1.0 dB Max @ 1-100 MHz
 -2.0 dB Max @ 100-250 MHz
6. Return Loss: -16 dB Min @ $1 \leq f \leq 40$ MHz
 -16+10log(f/40) dB Min @ $40 < f \leq 250$ MHz,
 where f is in MHz
7. Cross Talk: -30 dB Typ @ 1-250 MHz
8. Common Mode Rejection Ratio: -30 dB Typ @ 1-250 MHz
9. Isolation Hipot: 1500VAC 1mA 60S
10. Operating temperature 0°C to +70°C
11. Storage temperature -40°C to +85°C

D. PACKAGE INFORMATION

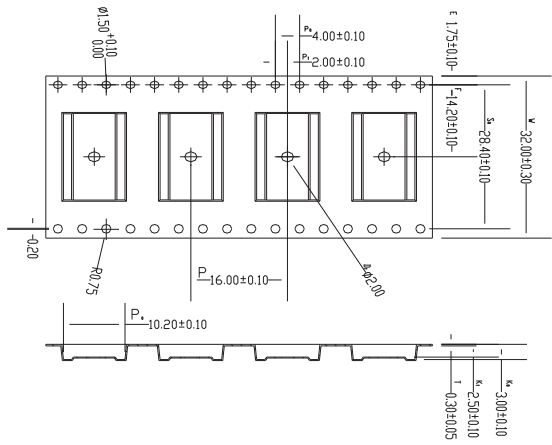

Package Quantity:
 One Reel=1500Pcs
 One Inner Carton=1500*2=3000Pcs
 One Export Carton=3000*2=6000Pcs

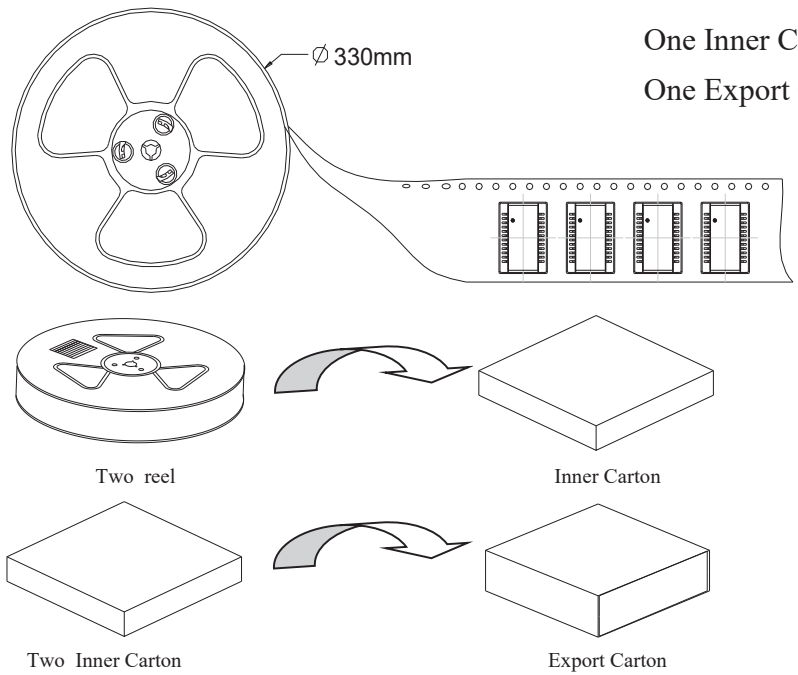

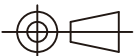
 苏州沃虎电子科技有限公司 Su Zhou Voohu Electronic Tech.Co.Ltd	TITLE: 2. 5/5GBASE-T	SIZE A4	UNITS MM[INCH]	GENERAL TOLERANCES UNLESS SPECIFIED		APPROVED BY: Geoffrey.Song
	PART NO.: WHSQ24301 G	SACLE 1:1	REV A0	x±0.35	x°±3.0°	CHECKED BY: Elvis.Song
	REMARK:	SHEET 2/2		.xx±0.25	.xx°±1.5°	DESIGND BY: Sunny.Xu
TEL: +86 400 1048 018	WEB: WWW.WOHU-TEK.COM			.xxx±0.10	.xxx°±1.0°	

H
G
F
E
D
C
B
A

H
G
F
E
D
C
B
A