

### A. MECHANICAL(unit:mm)

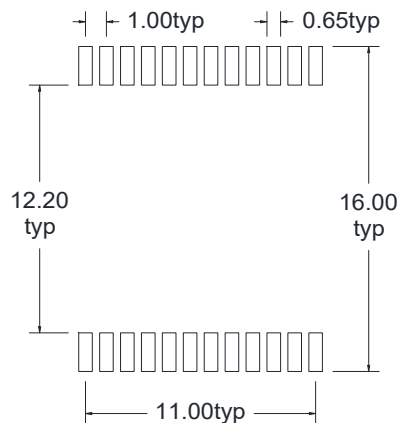

Suggested PAD Layout

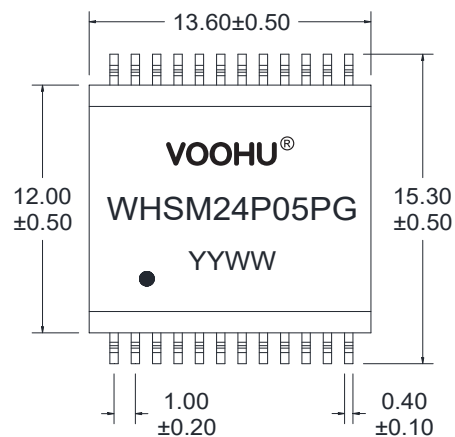
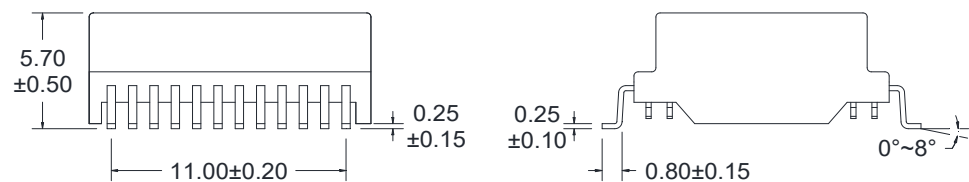

### B. SCHEMATICS

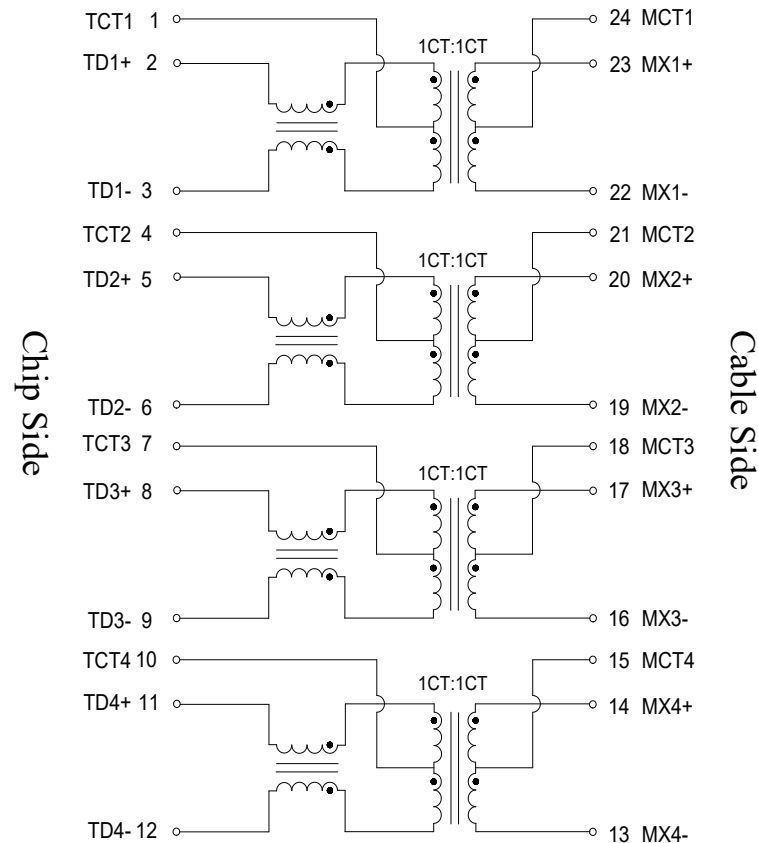

**VOOHU** 苏州沃虎电子科技有限公司  
Su Zhou Voohu Electronic Tech.Co.Ltd

TITLE:  
10G BASE-T

SIZE  
A4  
UNITS  
MM[INCH]

GENERAL TOLERANCES  
UNLESS SPECIFIED

APPROVED BY:  
Geoffrey.Song

PART NO.:  
WHSM24P05P G

SACLE  
1:1

REV  
A0

$x \pm 0.35$   
 $.x \pm 0.30$

CHECKED BY:  
Elvis.Song

REMARK:

SHEET  
1/3



$.xx \pm 0.25$   
 $.xxx \pm 0.10$

DESIGND BY:  
Sunny.Xu

TEL: +86 400 1048 018

WEB: [WWW.WOHU-TEK.COM](http://WWW.WOHU-TEK.COM)

**C. ELECTRICAL SPECIFICATIONS @25°C**

- |  |   |
|--|---|
| <p>1. OCL: 120 uH Min @100KHz 0.1V with 14mA DC Bias</p> <p>2. Leakage Inductance: 0.5uH Max @ 100KHz, 0.1V</p> <p>3. DCR: 900mΩ Max</p> <p>4. Turns Ratio: 1CT:1CT±5%</p> <p>5. Insertion Loss: -1.2dB max @ 1~200 MHz<br/>         -1.5dB max @ 200~300 MHz<br/>         -2.0dB max @ 300~400 MHz<br/>         -3.0dB max @ 400~500 MHz</p> <p>6. Return Loss: -18 dB Min @ 1~100 MHz<br/>         -16 dB Min @ 100~200 MHz<br/>         -12 dB Min @ 200~300 MHz<br/>         -10 dB Min @ 300~400 MHz<br/>         -8 dB Min @ 400~500 MHz</p> | <p>7. Cross Talk: -25 dB Typ @ 1-500 MHz</p> <p>8. Common Mode Rejection: -25 dB Typ @ 1-500 MHz</p> <p>9. Isolation Hipot: 1500VAC 1mA 60S</p> <p>10. Operating temperature 0°C to +70°C</p> <p>11. Storage temperature -40°C to +85°C</p> <p>12. PoE Support 30W: Each channel support 720mA DC balance current</p> |
|--|---|

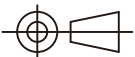
 <b>苏州沃虎电子科技有限公司</b> Su Zhou Voohu Electronic Tech.Co.Ltd	TITLE: 10G BASE-T		SIZE A4	UNITS MM[INCH]	GENERAL TOLERANCES UNLESS SPECIFIED		APPROVED BY: Geoffrey.Song
	PART NO.: WHSM24P05P G		SACLE 1:1	REV A0	.x±0.35 .x±0.30	x°±3.0° .x°±2.0°	CHECKED BY: Elvis.Song
	TEL: +86 400 1048 018	WEB: <a href="http://WWW.WOHU-TEK.COM">WWW.WOHU-TEK.COM</a>	REMARK:	SHEET 2/3		.xx±0.25 .xxx±0.10	.xx°±1.5° .xxx°±1.0°

# D. PACKAGE INFORMATION

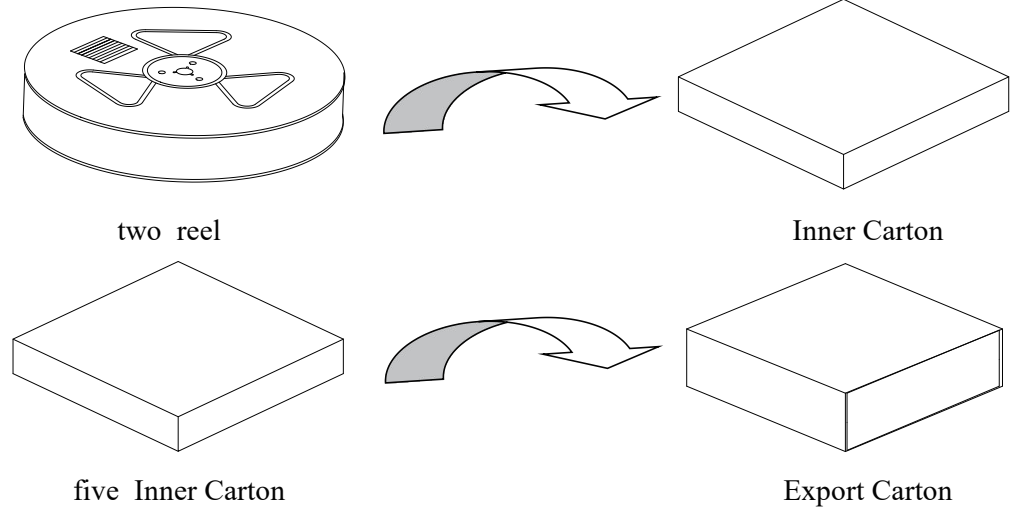
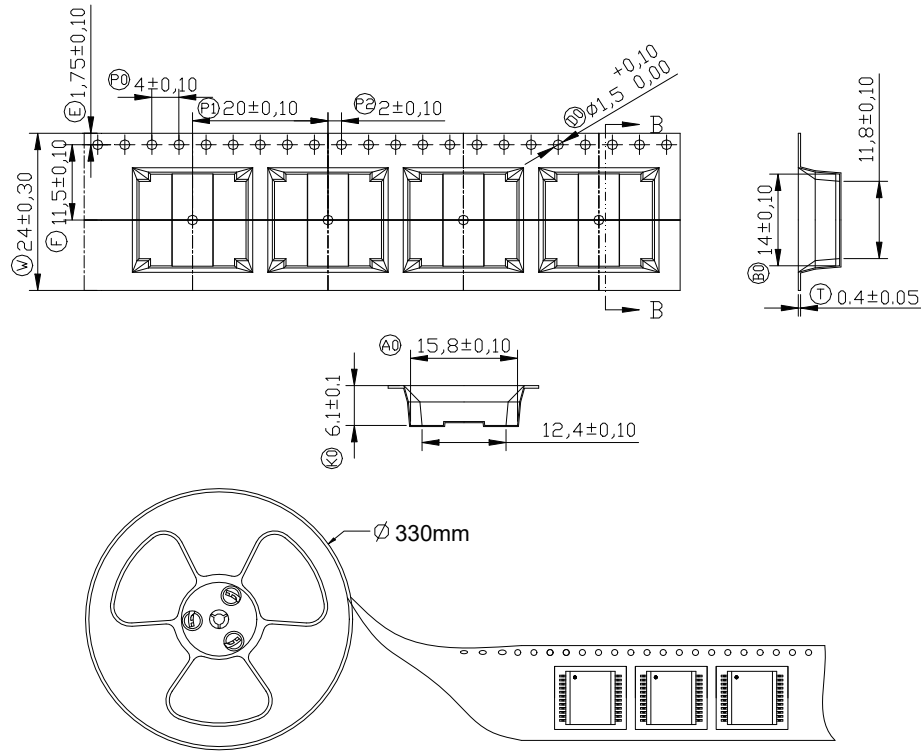

Package Quantity:

One Reel=450Pcs

One Inner Carton=450\*2=900Pcs

One Export Carton=900\*5=4500Pcs

**VOOHU** 苏州沃虎电子科技有限公司  
Su Zhou Voohu Electronic Tech.Co.Ltd

TITLE:  
10G BASE-T

SIZE  
A4

UNITS  
MM[INCH]

GENERAL TOLERANCES  
UNLESS SPECIFIED

APPROVED BY:  
Geoffrey.Song

PART NO.:  
WHSM24P05P G

SACLE  
1:1

REV  
A0

$x \pm 0.35$   
 $.x \pm 0.30$

$x^\circ \pm 3.0^\circ$   
 $.x^\circ \pm 2.0^\circ$

CHECKED BY:  
Elvis.Song

TEL: +86 400 1048 018

WEB: [WWW.WOHU-TEK.COM](http://WWW.WOHU-TEK.COM)

REMARK:

SHEET  
3/3

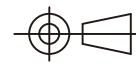

$.xx \pm 0.25$   
 $.xxx \pm 0.10$

$.xx^\circ \pm 1.5^\circ$   
 $.xxx^\circ \pm 1.0^\circ$

DESIGND BY:  
Sunny.Xu