

### A. MECHANICAL (unit:mm)

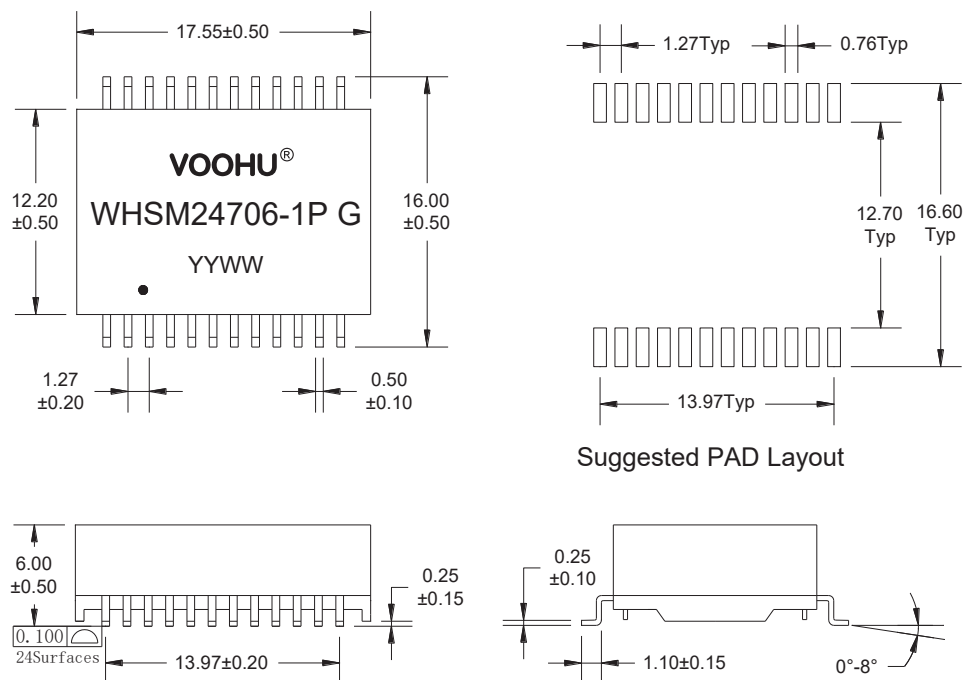

### B. SCHEMATICS

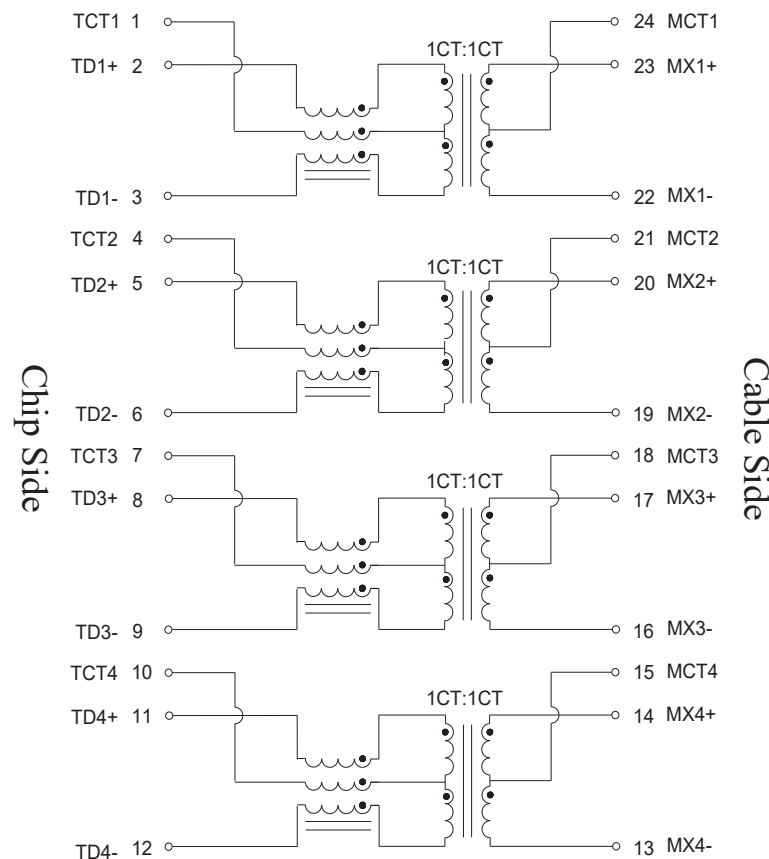

**VOOHU** 苏州沃虎电子科技有限公司  
Su Zhou Voohu Electronic Tech.Co.Ltd

TITLE:  
10G BASE-T

SIZE  
A4

UNITS  
MM[INCH]

GENERAL TOLERANCES  
UNLESS SPECIFIED

APPROVED BY:  
Geoffrey.Song

PART NO.:  
WHSM24706-1P G

SACLE  
1:1

REV  
A0

$x \pm 0.35$   
 $.x \pm 0.30$

$x^\circ \pm 3.0^\circ$   
 $.x^\circ \pm 2.0^\circ$

CHECKED BY:  
Elvis.Song

TEL: +86 400 1048 018

WEB: [WWW.WOHU-TEK.COM](http://WWW.WOHU-TEK.COM)

REMARK:

SHEET  
1/3

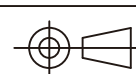

$.xx \pm 0.25$   
 $.xxx \pm 0.10$

$.xx^\circ \pm 1.5^\circ$   
 $.xxx^\circ \pm 1.0^\circ$

DESIGND BY:  
Sunny.Xu



# D. PACKAGE INFORMATION

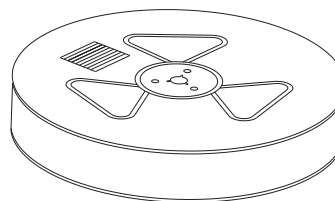
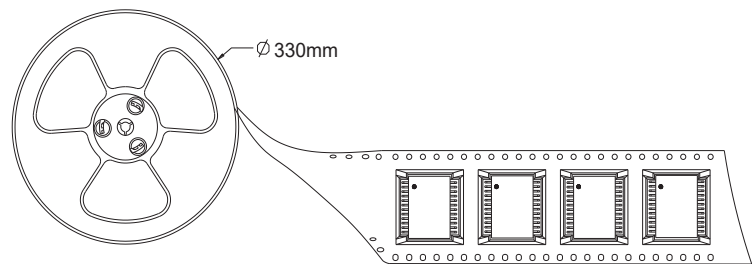
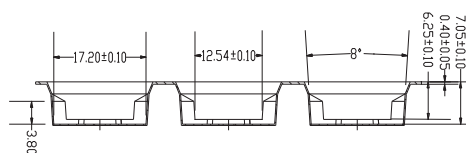
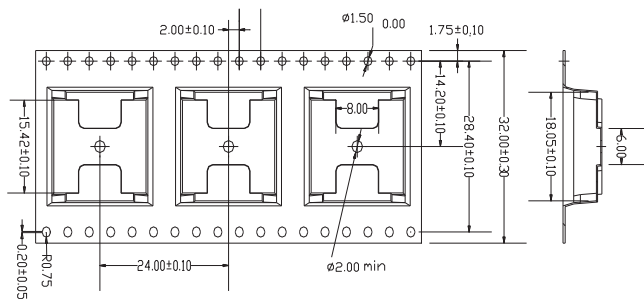

Two Reel

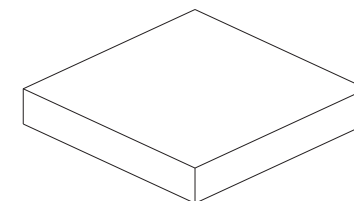

Inner Carton

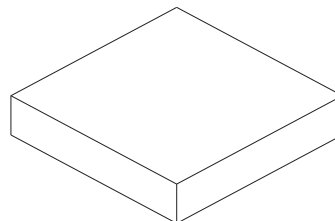

Five Inner Carton

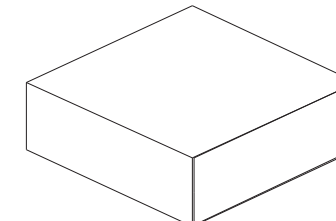

Export Carton

Package Quantity:

One Reel=350Pcs

One Inner Carton=350\*2=700Pcs

One Export Carton=700\*5=3500Pcs

**VOOHU** 苏州沃虎电子科技有限公司  
Su Zhou Voohu Electronic Tech.Co.Ltd

TITLE:  
10G BASE-T

SIZE  
A4  
UNITS  
MM[INCH]

GENERAL TOLERANCES  
UNLESS SPECIFIED

APPROVED BY:  
Geoffrey.Song

PART NO.:  
WHSM24706-1P G

SACLE  
1:1  
REV  
A0

$x \pm 0.35$      $x^\circ \pm 3.0^\circ$   
 $.x \pm 0.30$      $.x^\circ \pm 2.0^\circ$

CHECKED BY:  
Elvis.Song

TEL: +86 400 1048 018

WEB: [WWW.WOHU-TEK.COM](http://WWW.WOHU-TEK.COM)

REMARK:

SHEET  
3/3



$.xx \pm 0.25$      $.xx^\circ \pm 1.5^\circ$   
 $.xxx \pm 0.10$      $.xxx^\circ \pm 1.0^\circ$

DESIGND BY:  
Sunny.Xu