

A. MECHANICAL(unit:mm)

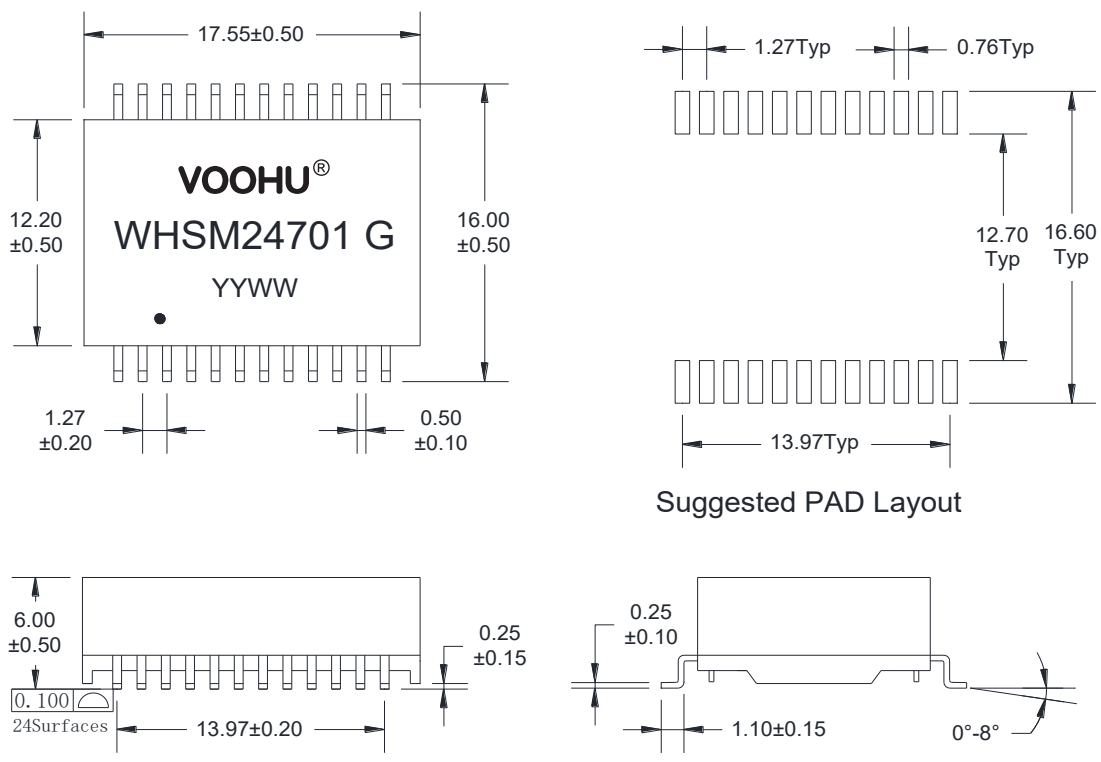

B. SCHEMATICS

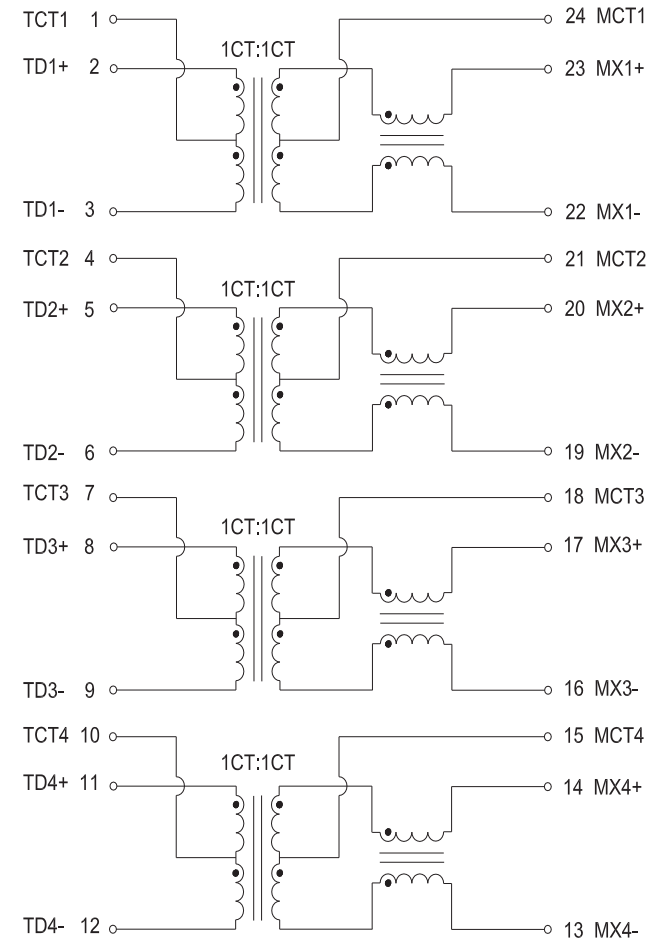

VOOHU 苏州沃虎电子科技有限公司
Su Zhou Voohu Electronic Tech.Co.Ltd

TITLE: 10G BASE-T
PART NO.: WHSM24701 G
REMARK:

SIZE A4
UNITS MM[INCH]
SACLE 1:1
REV A0
SHEET 1/2

GENERAL TOLERANCES UNLESS SPECIFIED
x±0.35 x°±3.0°
.x±0.30 .x°±2.0°
.xx±0.25 .xx°±1.5°
.xxx±0.10 .xxx°±1.0°

APPROVED BY: Geoffrey.Song
CHECKED BY: Elvis.Song
DESIGND BY: Sunny.Xu

TEL: +86 400 1048 018 WEB: WWW.WOHU-TEK.COM

H
G
F
E
D
C
B
A

H
G
F
E
D
C
B
A

C. ELECTRICAL SPECIFICATIONS @25°C

1. OCL: 120 uH Min @100KHz 0.1V
2. Leakage Inductance: 0.5uH Max @ 100KHz, 0.1V
3. DCR: 900mΩ Max
4. Turns Ratio: 1CT:1CT±5%
5. Insertion Loss: -1.2dB max @ 1~200 MHz
 -1.5dB max @ 200~300 MHz
 -2.0dB max @ 300~400 MHz
 -3.0dB max @ 400~500 MHz
6. Return Loss: -18 dB Min @ 1~100 MHz
 -16 dB Min @ 100~200 MHz
 -12 dB Min @ 200~300 MHz
 -10 dB Min @ 300~400 MHz
 -8 dB Min @ 400~500 MHz
7. Cross Talk: -25 dB Typ @ 1-500 MHz
8. Common Mode Rejection: -25 dB Typ @ 1-500 MHz
9. Isolation Hipot: 1500VAC 1mA 60S
10. Operating temperature -40°C to +85°C
11. Storage temperature -40°C to +85°C

D. PACKAGE INFORMATION

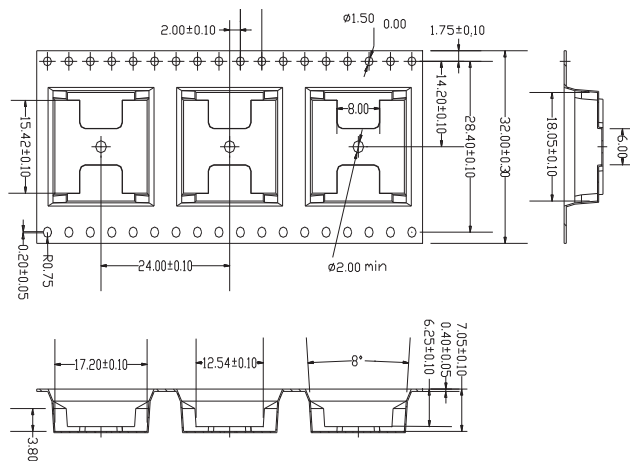

Package Quantity:

One Reel=350Pcs

One Inner Carton=350*2=700Pcs

One Export Carton=700*5=3500Pcs

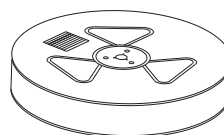
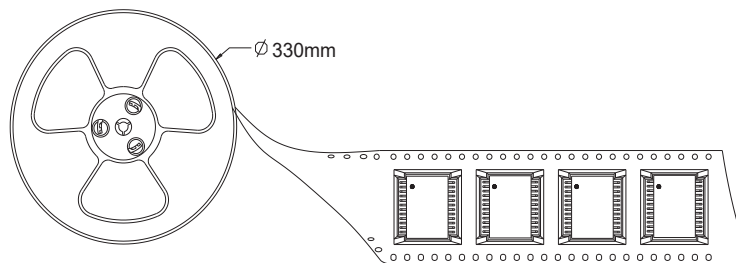

Two Reel

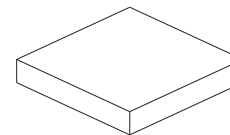

Inner Carton

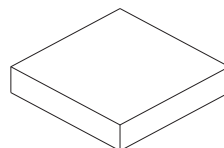

Five Inner Carton

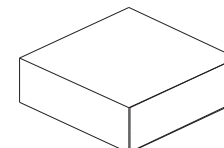

Export Carton

VOOHU 苏州沃虎电子科技有限公司
Su Zhou Voohu Electronic Tech.Co.Ltd

TITLE:
10G BASE-T

SIZE
A4

UNITS
MM[INCH]

GENERAL TOLERANCES
UNLESS SPECIFIED

APPROVED BY:
Geoffrey.Song

PART NO.:
WHSM24701 G

SACLE
1:1

REV
A0

x±0.35
.x±0.30

x°±3.0°
.x°±2.0°

CHECKED BY:
Elvis.Song

TEL: +86 400 1048 018

WEB: WWW.WOHU-TEK.COM

REMARK:

SHEET
1/2



.xx±0.25
.xxx±0.10

.xx°±1.5°
.xxx°±1.0°

DESIGND BY:
Sunny.Xu