

A. MECHANICAL(unit:mm)

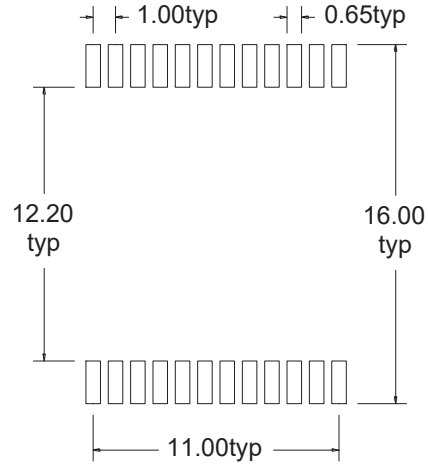

Suggested PAD Layout

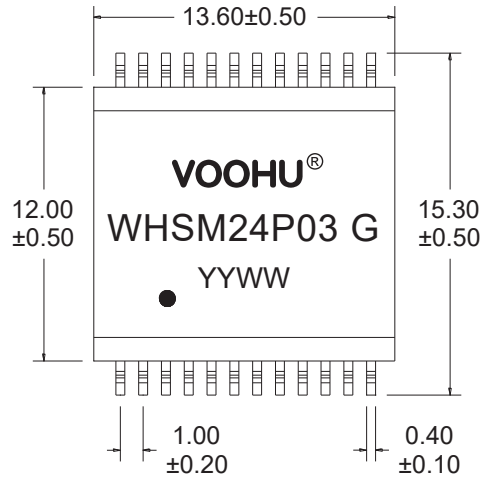
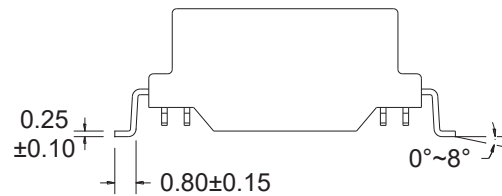
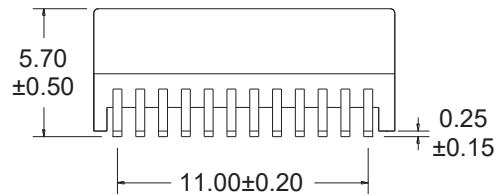

B. SCHEMATICS

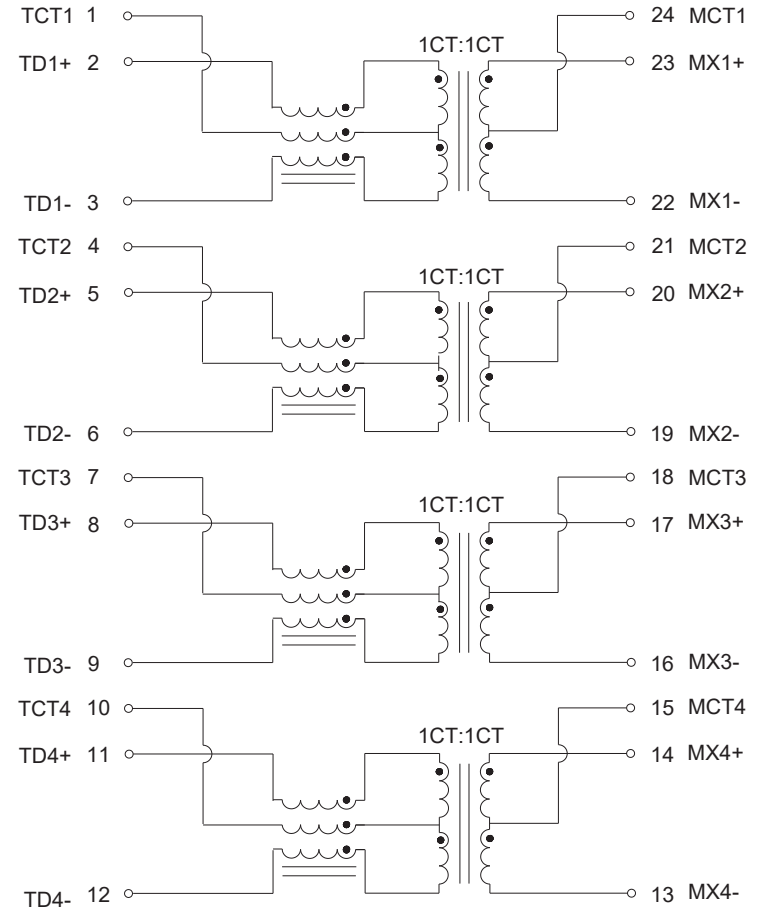

VOOHU 苏州沃虎电子科技有限公司
 Su Zhou Voohu Electronic Tech.Co.Ltd

TITLE:
10G BASE-T

SIZE
A4

UNITS
MM[INCH]

GENERAL TOLERANCES
UNLESS SPECIFIED

APPROVED BY:
Geoffrey.Song

PART NO.:
WHSM24P03 G

SACLE
1:1

REV
A0

$x \pm 0.35$
 $.x \pm 0.30$

CHECKED BY:
Elvis.Song

TEL: +86 400 1048 018

WEB: WWW.WOHU-TEK.COM

REMARK:

SHEET
1/3

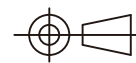

$.xx \pm 0.25$
 $.xxx \pm 0.10$

DESIGND BY:
Sunny.Xu

C. ELECTRICAL SPECIFICATIONS @25°C

- | | |
|--|---|
| <p>1. OCL: 120 uH Min @100KHz 0.1V</p> <p>2. Leakage Inductance: 0.5uH Max @ 100KHz, 0.1V</p> <p>3. DCR: 900mΩ Max</p> <p>4. Turns Ratio: 1CT:1CT±5%</p> <p>5. Insertion Loss: -1.2dB max @ 1~200 MHz
 -1.5dB max @ 200~300 MHz
 -2.0dB max @ 300~400 MHz
 -3.0dB max @ 400~500 MHz</p> <p>6. Return Loss: -18 dB Min @ 1~100 MHz
 -16 dB Min @ 100~200 MHz
 -12 dB Min @ 200~300 MHz
 -10 dB Min @ 300~400 MHz
 -8 dB Min @ 400~500 MHz</p> | <p>7. Cross Talk: -25 dB Typ @ 1-500 MHz</p> <p>8. Common Mode Rejection: -25 dB Typ @ 1-500 MHz</p> <p>9. Isolation Hipot: 1500VAC 1mA 60S</p> <p>10. Operating temperature 0°C to +70°C</p> <p>11. Storage temperature -40°C to +85°C</p> |
|--|---|

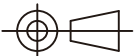
 苏州沃虎电子科技有限公司 Su Zhou Voohu Electronic Tech.Co.Ltd	TITLE: 10G BASE-T		SIZE A4	UNITS MM[INCH]	GENERAL TOLERANCES UNLESS SPECIFIED		APPROVED BY: Geoffrey.Song
	PART NO.: WHSM24P03 G		SACLE 1:1	REV A0	.x±0.35 .x±0.30	x°±3.0° .x°±2.0°	CHECKED BY: Elvis.Song
	TEL: +86 400 1048 018	WEB: WWW.WOHU-TEK.COM	REMARK:	SHEET 2/3		.xx±0.25 .xxx±0.10	.xx°±1.5° .xxx°±1.0°

D. PACKAGE INFORMATION

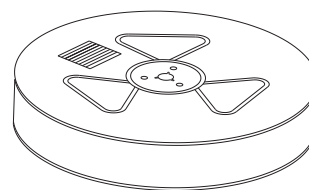
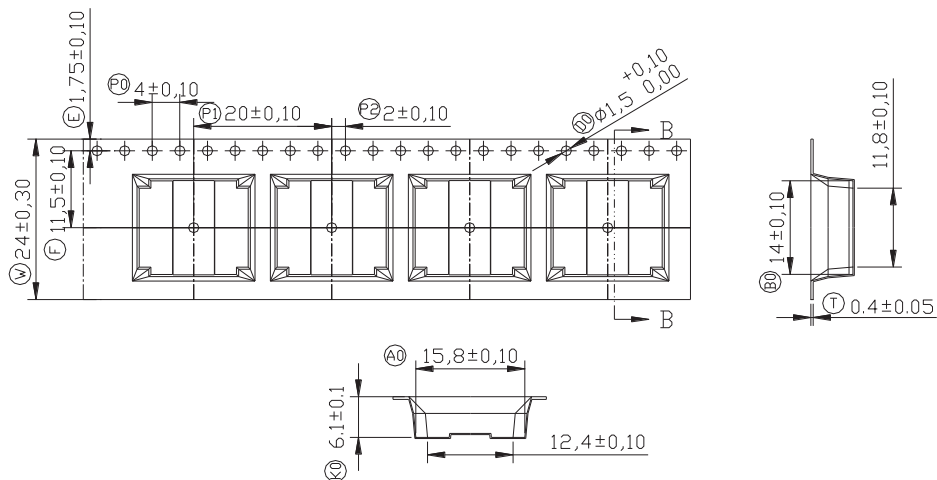

Two Reel

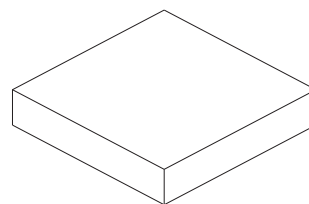

Five Inner Carton

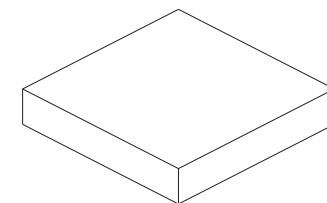

Inner Carton

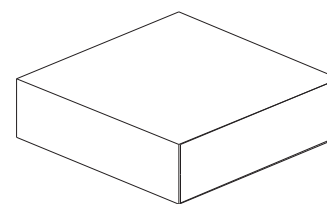

Export Carton

Package Quantity:

One Reel=450Pcs

One Inner Carton=450*2=900Pcs

One Export Carton=900*5=4500Pcs

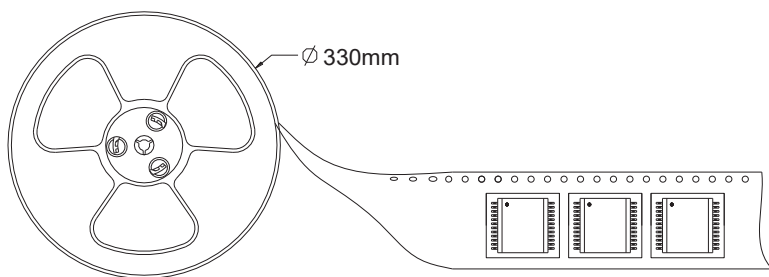

VOOHU 苏州沃虎电子科技有限公司
Su Zhou Voohu Electronic Tech.Co.Ltd

TITLE: 10G BASE-T
PART NO.: WHSM24P03 G

REMARK:

SIZE A4
UNITS MM[INCH]
SACLE 1:1
REV A0
SHEET 3/3



GENERAL TOLERANCES UNLESS SPECIFIED

$x \pm 0.35$	$x^\circ \pm 3.0^\circ$
$.x \pm 0.30$	$.x^\circ \pm 2.0^\circ$
$.xx \pm 0.25$	$.xx^\circ \pm 1.5^\circ$
$.xxx \pm 0.10$	$.xxx^\circ \pm 1.0^\circ$

APPROVED BY: Geoffrey.Song
CHECKED BY: Elvis.Song
DESIGND BY: Sunny.Xu

TEL: +86 400 1048 018

WEB: WWW.WOHU-TEK.COM